

有关本公司产品的注意事项

请务必在使用本公司产品目录之前阅读。

⚠ 注意事项

■ 本产品目录中记载的内容是至2013年10月的内容。本产品目录记载的内容由于产品的改良等原因发生变更时，恕不另行通知。在您订购我司产品之前请确认最新的产品信息。

当您计划在本产品目录记载内容，或是《交货规格书》的规定范围以外使用我司产品时，由于使用我司产品引起的该应用设备的瑕疵我司将不承担任何责任。

■ 有关详细的产品规格我们准备有《交货规格书》，请向我司咨询相关事宜。

■ 在您使用我司产品时，请务必进行应用设备实装状态以及应用产品实际使用环境下的测评。

■ 本产品目录中记载的电子元器件，电路产品等产品适用于一般电子设备。

『AV设备，OA设备，家电及办公设备，信息/通讯设备（手机，电脑等）』

当您计划把本产品目录中记载的产品使用于可能会危及第三方生命安全的应用设备时，请务必提前与我公司取得联系，针对产品信息加以确认。

【运输用设备（火车控制设备，船舶控制设备等），交通用信号设备，防灾设备，医疗用设备，公共性高的信息通信设备等（电话程控交换机，电话，无线电，电视信号等基地局）】

另外，请不要在要求高度安全性，可靠性的应用设备上使用本产品目录中记载的产品。【航天设备，航空设备，核控制设备，用于海底的设备，军事设备等】

同时，应用于安全性，可靠性要求较高的一般电子设备/电路时，请充分进行安全性测评，必要时请在设计过程中追加保护电路。

■ 本产品目录中所记载的内容适用于通过我司营业所，销售子公司，销售代理店（即正规销售渠道）购买的我司产品。通过其他渠道购买的我司产品不在适用范围之内。

■ 由于使用本产品目录记载的产品引起的有关第三方知识产权的冲突，我司概不负责。本产品目录不代表相关权利的实施许诺。

■ 有关出口的注意事项

本产品目录中记载的产品中，部分产品在出口时会被归为“外汇及外贸管理法，美国出口管理法规”的管制货物，请及时实施相关手续，依据相关法律法规进行出口。需确认时，可向我司咨询。



波峰焊

回流焊

■ 型号标示法

J	M	K	3	1	6	△	B	J	1	0	6	M	L	-	T	△
①	②	③	④	⑤	⑥	⑦	⑧	⑨	⑩	⑪	⑫					

△=空格

① 额定电压

代码	额定电压 [VDC]
P	2.5
A	4
J	6.3
L	10
E	16
T	25
G	35
U	50
H	100
Q	250
S	630

② 系列名称

代码	系列名称
M	多层电容器
V	高频用多层电容器
W	LW 逆转型多层电容器

③ 端接类型

代码	端接类型
K	电镀
S	Cu 内部电极

④ 外型尺寸

规格	L × W [mm]	EIA (inch)
042	0.4 × 0.2	01005
063	0.6 × 0.3	0201
105	1.0 × 0.5	0402
	0.52 × 1.0 ※	0204
107	1.6 × 0.8	0603
	0.8 × 1.6 ※	0306
212	2.0 × 1.25	0805
	1.25 × 2.0 ※	0508
316	3.2 × 1.6	1206
325	3.2 × 2.5	1210
432	4.5 × 3.2	1812

注: ※LW 逆转型(□WK)

⑤ 产品尺寸公差

代码	规格	L [mm]	W [mm]	T [mm]	
△	所有规格	标准	标准	标准	
	A	063	0.6±0.05	0.3±0.05	0.3±0.05
		105	1.0±0.10	0.5±0.10	0.5±0.10
107		1.6+0.15/-0.05	0.8+0.15/-0.05	0.8+0.15/-0.05	
A	212	2.0+0.15/-0.05	1.25+0.15/-0.05	0.45±0.05	
				0.85±0.10	
				1.25+0.15/-0.05	
				0.85±0.10	
A	316	3.2±0.20	1.6±0.20	1.6±0.20	
				2.5±0.30	
B	105	1.0+0.15/-0.05	0.5+0.15/-0.05	0.5+0.15/-0.05	
				0.45±0.05	
				0.8+0.20/-0	
				0.85±0.10	
B	212	2.0+0.20/-0	1.25+0.20/-0	1.25+0.20/-0	
				1.6±0.30	
C	105	1.0+0.20/-0	0.5+0.20/-0	0.5+0.20/-0	

注:P.6 标准产品尺寸

△=空格

⑥ 温度特性

■ 高介电常数【超低失真多层陶瓷电容器 (FCGAP™) 除外】

代码	适用标准	温度范围 [°C]	基准温度 [°C]	静电容量变化率	静电容量允许偏差	允许偏差代码
BJ	JIS B	-25~+85	20	±10%	±10%	K
	EIA X5R	-55~+85	25	±15%	±20%	M
B7	EIA X7R	-55~+125	25	±15%	±10%	K
					±20%	M
C6	EIA X6S	-55~+105	25	±22%	±10%	K
					±20%	M
C7	EIA X7S	-55~+125	25	±22%	±10%	K
					±20%	M
LD(※)	EIA X5R	-55~+85	25	±15%	±10%	K
					±20%	M
△F	JIS F	-25~+85	20	+30/-80%	+80/-20%	Z
	EIA Y5V	-30~+85	25	+22/-82%	+80/-20%	Z

注: ※LD 低失真大容量多层陶瓷电容器

△=空格

■温度补偿用

代码	适用标准		温度范围[°C]	基准温度[°C]	静电容量变化率	静电容量允许偏差	允许偏差代码
CG	JIS	CG	-55~+125	20	0±30ppm/°C	±0.1pF	B
						±0.25pF	C
						±0.5pF	D
						±1pF	F
						±5%	J
CH	JIS	CH	-55~+125	20	0±60ppm/°C	±0.1pF	B
						±0.25pF	C
						±0.5pF	D
						±1pF	F
						±5%	J
					±10%	K	
CJ	JIS	CJ	-55~+125	20	0±120ppm/°C	±0.25pF	C
CK	JIS	CK	-55~+125	20	0±250ppm/°C	±0.25pF	C
UJ	JIS	UJ	-55~+125	20	-750±120ppm/°C	±0.25pF	C
						±0.5pF	D
						±5%	J
UK	JIS	UK	-55~+125	20	-750±250ppm/°C	±0.25pF	C
SL	JIS	SL	-55~+125	20	+350~-1000ppm/°C	±5%	J

⑥系列名称

·超低失真多层陶瓷电容器(CFCAP™)

代码	系列名称
SD	标准品

⑦静电容量

代码(例)	静电容量
OR5	0.5pF
O10	1pF
100	10pF
101	100pF
102	1,000pF
103	10,000pF
104	0.1μF
105	1μF
106	10μF
107	100μF

注: R=小数点

⑧静电容量允许偏差

代码	静电容量允许偏差
B	±0.1pF
C	±0.25pF
D	±0.5pF
F	±1pF
G	±2%
J	±5%
K	±10%
M	±20%
Z	+80/-20%

⑨产品厚度

代码	产品厚度[mm]
C	0.2
D	
P	
T	0.3
K	
V	0.45
W	
A	0.5
D	0.8
F	0.85(212型以上)
G	1.15
L	1.25
N	1.6
Y	1.9
M	2.0 max
	2.5

⑩个别规格

代码	个别规格
-	标准

⑪包装

代码	包装规格
F	φ178mm 卷盘带装 (2mm 间距)
T	φ178mm 卷盘带装 (4mm 间距)
P	φ178mm 卷盘带装 (4mm 间距, 1000 个/卷盘) 325 规格(厚度代码 M)
W	φ178mm 压纹带(1mm 间距) 042 规格专用

⑫管理记号

代码	管理记号
△	标准

■标准产品尺寸

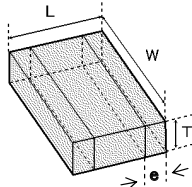
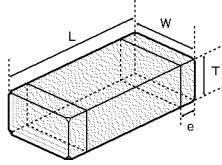

※LW 逆转型

Type(EIA)	标准产品尺寸[mm]				
	L	W	T	*1	e
□MK042(01005)	0.4±0.02	0.2±0.02	0.2±0.02	C D	0.1±0.03
□VS042(01005)	0.4±0.02	0.2±0.02	0.2±0.02	C	0.1±0.03
□MK063(0201)	0.6±0.03	0.3±0.03	0.3±0.03	P T	0.15±0.05
□MK105(0402)	1.0±0.05	0.5±0.05	0.2±0.02 0.3±0.03 0.5±0.05	C P V	0.25±0.10
□VK105(0402)	1.0±0.05	0.5±0.05	0.5±0.05	W	0.25±0.10
□WK105(0204)※	0.52±0.05	1.0±0.05	0.3±0.05	P	0.18±0.08
□MK107(0603)	1.6±0.10	0.8±0.10	0.45±0.05 0.8±0.10	K A	0.35±0.25
□WK107(0306)※	0.8±0.10	1.6±0.10	0.5±0.05	V	0.25±0.15
□MK212(0805)	2.0±0.10	1.25±0.10	0.45±0.05 0.85±0.10 1.25±0.10	K D G	0.5±0.25
□WK212(0508)※	1.25±0.15	2.0±0.15	0.85±0.1	D	0.3±0.2
□MK316(1206)	3.2±0.15	1.6±0.15	0.85±0.10 1.15±0.10 1.25±0.10 1.6±0.20	D F G L	0.5+0.35/-0.25
□MK325(1210)	3.2±0.30	2.5±0.20	0.85±0.10 1.15±0.10 1.9±0.20 1.9+0.1/-0.2 2.5±0.20	D F N Y M	0.6±0.3
□MK432(1812)	4.5±0.40	3.2±0.30	2.5±0.20	M	0.9±0.6

注：※LW 逆转型、*1 产品厚度代码

■标准包装

规格	EIA (inch)	产品厚度		标准数量 [pcs]	
		[mm]	代码	纸带	压纹带
042	01005	0.2	C	—	40000
			D		
063	0201	0.3	P	15000	—
			T		
105	0402	0.2	C	20000	—
		0.3	P	15000	—
		0.5	V	10000	—
		W			
0204 ※	0.30	P			
107	0603	0.45	K	4000	—
		0.8	A		
	0306 ※	0.50	V	—	4000
212	0805	0.45	K	4000	—
		0.85	D	—	3000
		1.25	G	—	—
0508 ※	0.85	D	4000	—	
316	1206	0.85	D	4000	—
		1.15	F	—	3000
		1.25	G	—	—
		1.6	L	—	2000
325	1210	0.85	D	—	2000
		1.15	F		
		1.9	N		
		2.0 max	Y		
		2.5	M	—	500(T), 1000(P)
432	1812	2.5	M	—	500

注：※LW 逆转型(□WK)

▶ 本产品目录根据版面大小，仅记载了代表性产品规格，若考虑使用本公司产品时，请确认供货规格型号明细表中的详细规格。有关各商品的详细信息(特性图、可靠性信息、使用时的注意事项等)，请参阅本公司网站(<http://www.ty-top.com/>)。

●本产品目录中记载的多层陶瓷电容器全部是RoHS对应品。
 ●请在型号的口中指定静电容量允许偏差代码。

注)

- *1 根据个别规格的约定，也会有采取温度特性为X7R/X7S的产品对应的情况。
- *2 根据使用电路和机器，需要按照相应规格处理。请务必咨询正规销售渠道。
- *3 关于尺寸规格，请参照型号标示法的④外形尺寸、⑤产品尺寸公差、⑨产品厚度、P.6标准产品尺寸。

多层陶瓷电容器(高介电常数)

●042型

【温度特性 BJ : B/X5R】 厚度 0.2mm(C)

型号1	型号2	额定电压[V]	温度特性		静电容量 [F]	静电容量允许偏差 [%]	tan δ [%]	高温负载	厚度*3 [mm]	焊接方式 R:回流焊 W:波峰焊	
								额定电压 x %			
LMK042 BJ101□C-W		10	B	X5R*1	100 p	±10, ±20	5	200	0.2±0.02	R	
LMK042 BJ151□C-W			B	X5R*1	150 p	±10, ±20	5	200	0.2±0.02	R	
LMK042 BJ221□C-W			B	X5R*1	220 p	±10, ±20	5	200	0.2±0.02	R	
LMK042 BJ331□C-W			B	X5R*1	330 p	±10, ±20	5	200	0.2±0.02	R	
LMK042 BJ471□C-W			B	X5R*1	470 p	±10, ±20	5	200	0.2±0.02	R	
LMK042 BJ681□C-W			B	X5R*1	680 p	±10, ±20	5	200	0.2±0.02	R	
LMK042 BJ102□C-W			B	X5R*1	1000 p	±10, ±20	5	200	0.2±0.02	R	
LMK042 BJ152□C-W			X5R		1500 p	±10, ±20	10	150	0.2±0.02	R	
LMK042 BJ222□C-W			X5R		2200 p	±10, ±20	10	150	0.2±0.02	R	
LMK042 BJ332□C-W			X5R		3300 p	±10, ±20	10	150	0.2±0.02	R	
LMK042 BJ472□C-W			X5R		4700 p	±10, ±20	10	150	0.2±0.02	R	
LMK042 BJ682□C-W			X5R		6800 p	±10, ±20	10	150	0.2±0.02	R	
LMK042 BJ103□C-W			X5R		10000 p	±10, ±20	10	150	0.2±0.02	R	
JMK042 BJ152□C-W			6.3	B	X5R*1	1500 p	±10, ±20	10	150	0.2±0.02	R
JMK042 BJ222□C-W				B	X5R*1	2200 p	±10, ±20	10	150	0.2±0.02	R
JMK042 BJ332□C-W				B	X5R*1	3300 p	±10, ±20	10	150	0.2±0.02	R
JMK042 BJ472□C-W		B		X5R*1	4700 p	±10, ±20	10	150	0.2±0.02	R	
JMK042 BJ682□C-W		B		X5R*1	6800 p	±10, ±20	10	150	0.2±0.02	R	
JMK042 BJ103□C-W		B		X5R*1	10000 p	±10, ±20	10	150	0.2±0.02	R	
JMK042 BJ223□C-W		X5R			22000 p	±10, ±20	10	150	0.2±0.02	R	
JMK042 BJ473□C-W		X5R			47000 p	±10, ±20	10	150	0.2±0.02	R	
AMK042 BJ473□C-W		4	X5R		47000 p	±10, ±20	10	150	0.2±0.02	R	
AMK042 BJ104□C-W			X5R		0.1 μ	±10, ±20	10	150	0.2±0.02	R	

【温度特性 B7 : X7R】 厚度 0.2mm(C)

型号1	型号2	额定电压[V]	温度特性		静电容量 [F]	静电容量允许偏差 [%]	tan δ [%]	高温负载	厚度*3 [mm]	焊接方式 R:回流焊 W:波峰焊	
								额定电压 x %			
EMK042 B7101□C-W		16		X7R	100 p	±10, ±20	5	200	0.2±0.02	R	
EMK042 B7151□C-W				X7R	150 p	±10, ±20	5	200	0.2±0.02	R	
EMK042 B7221□C-W				X7R	220 p	±10, ±20	5	200	0.2±0.02	R	
EMK042 B7331□C-W				X7R	330 p	±10, ±20	5	200	0.2±0.02	R	
EMK042 B7471□C-W				X7R	470 p	±10, ±20	5	200	0.2±0.02	R	
EMK042 B7681□C-W				X7R	680 p	±10, ±20	5	200	0.2±0.02	R	
EMK042 B7102□C-W				X7R	1000 p	±10, ±20	5	200	0.2±0.02	R	
LMK042 B7101□C-W			10		X7R	100 p	±10, ±20	5	200	0.2±0.02	R
LMK042 B7151□C-W					X7R	150 p	±10, ±20	5	200	0.2±0.02	R
LMK042 B7221□C-W					X7R	220 p	±10, ±20	5	200	0.2±0.02	R
LMK042 B7331□C-W				X7R	330 p	±10, ±20	5	200	0.2±0.02	R	
LMK042 B7471□C-W				X7R	470 p	±10, ±20	5	200	0.2±0.02	R	
LMK042 B7681□C-W				X7R	680 p	±10, ±20	5	200	0.2±0.02	R	
LMK042 B7102□C-W			X7R	1000 p	±10, ±20	5	200	0.2±0.02	R		

●063型

【温度特性 BJ : B/X5R】 厚度 0.3mm(P)

型号1	型号2	额定电压[V]	温度特性		静电容量 [F]	静电容量允许偏差 [%]	tan δ [%]	高温负载	厚度*3 [mm]	焊接方式 R:回流焊 W:波峰焊	
								额定电压 x %			
UMK063 BJ101□P-F		50	B	X5R*1	100 p	±10, ±20	3.5	200	0.3±0.03	R	
UMK063 BJ151□P-F			B	X5R*1	150 p	±10, ±20	3.5	200	0.3±0.03	R	
UMK063 BJ221□P-F			B	X5R*1	220 p	±10, ±20	3.5	200	0.3±0.03	R	
UMK063 BJ331□P-F			B	X5R*1	330 p	±10, ±20	3.5	200	0.3±0.03	R	
UMK063 BJ471□P-F			B	X5R*1	470 p	±10, ±20	3.5	200	0.3±0.03	R	
UMK063 BJ681□P-F			B	X5R*1	680 p	±10, ±20	3.5	200	0.3±0.03	R	
UMK063 BJ102□P-F			B	X5R*1	1000 p	±10, ±20	3.5	200	0.3±0.03	R	
UMK063 BJ152□P-F			B	X5R	1500 p	±10, ±20	5	200	0.3±0.03	R	
UMK063 BJ222□P-F			B	X5R	2200 p	±10, ±20	5	200	0.3±0.03	R	
UMK063 BJ332□P-F			B	X5R	3300 p	±10, ±20	5	200	0.3±0.03	R	
UMK063 BJ472□P-F			B	X5R	4700 p	±10, ±20	5	200	0.3±0.03	R	
UMK063 BJ682□P-F			B	X5R	6800 p	±10, ±20	5	200	0.3±0.03	R	
UMK063 BJ103□P-F			B	X5R	10000 p	±10, ±20	5	200	0.3±0.03	R	
TMK063 BJ152□P-F			25	B	X5R	1500 p	±10, ±20	5	200	0.3±0.03	R
TMK063 BJ222□P-F				B	X5R	2200 p	±10, ±20	5	200	0.3±0.03	R
TMK063 BJ332□P-F				B	X5R	3300 p	±10, ±20	5	200	0.3±0.03	R
TMK063 BJ472□P-F		B		X5R	4700 p	±10, ±20	5	200	0.3±0.03	R	
TMK063 BJ682□P-F		B		X5R	6800 p	±10, ±20	5	200	0.3±0.03	R	
TMK063 BJ103□P-F		B		X5R	10000 p	±10, ±20	5	200	0.3±0.03	R	
TMK063 BJ223□P-F		B		X5R	22000 p	±10, ±20	7.5	150	0.3±0.03	R	
EMK063 BJ152□P-F		16		B	X5R*1	1500 p	±10, ±20	5	200	0.3±0.03	R
EMK063 BJ222□P-F			B	X5R*1	2200 p	±10, ±20	5	200	0.3±0.03	R	
EMK063 BJ332□P-F			B	X5R*1	3300 p	±10, ±20	5	200	0.3±0.03	R	
EMK063 BJ472□P-F			B	X5R*1	4700 p	±10, ±20	5	200	0.3±0.03	R	
EMK063 BJ682□P-F			B	X5R*1	6800 p	±10, ±20	5	200	0.3±0.03	R	
EMK063 BJ103□P-F			B	X5R*1	10000 p	±10, ±20	5	200	0.3±0.03	R	
EMK063 BJ223□P-F			B	X5R	22000 p	±10, ±20	7.5	150	0.3±0.03	R	
EMK063 BJ333□P-F			X5R		33000 p	±10, ±20	7.5	150	0.3±0.03	R	
EMK063 BJ473□P-F			X5R		47000 p	±10, ±20	7.5	150	0.3±0.03	R	
EMK063 BJ683□P-F			X5R		68000 p	±10, ±20	10	150	0.3±0.03	R	
EMK063 BJ104□P-F			X5R		0.1 μ	±10, ±20	10	150	0.3±0.03	R	
EMK063 BJ224□P-F			X5R		0.22 μ	±10, ±20	10	150	0.3±0.03	R	

▶ 本产品目录根据版面大小，仅记载了代表性产品规格，若考虑使用本公司产品时，请确认供货规格型号明细表中的详细规格。
 有关各商品的详细信息(特性图、可靠性信息、使用时的注意事项等)，请参阅本公司网站(<http://www.ty-top.com/>)。

●型号一览

型号1	型号2	额定电压 [V]	温度特性		静电容量 [F]	静电容量允许偏差 [%]	tan δ [%]	高温负载	厚度*3 [mm]	焊接方式 R:回流焊 W:波峰焊
								额定电压 x %		
LMK063 BJ223□P-F		10	B	X5R	22000 p	±10, ±20	7.5	150	0.3±0.03	R
LMK063 BJ333□P-F			X5R	X5R	33000 p	±10, ±20	7.5	150	0.3±0.03	R
LMK063 BJ473□P-F			X5R	X5R	47000 p	±10, ±20	7.5	150	0.3±0.03	R
LMK063 BJ683□P-F			X5R	X5R	68000 p	±10, ±20	10	150	0.3±0.03	R
LMK063 BJ104□P-F			X5R	X5R	0.1 μ	±10, ±20	10	150	0.3±0.03	R
LMK063 BJ224□P-F			X5R	X5R	0.22 μ	±10, ±20	10	150	0.3±0.03	R
JMK063 BJ223□P-F			B	X5R	22000 p	±10, ±20	7.5	150	0.3±0.03	R
JMK063 BJ333□P-F			X5R	X5R	33000 p	±10, ±20	7.5	150	0.3±0.03	R
JMK063 BJ473□P-F			X5R	X5R	47000 p	±10, ±20	7.5	150	0.3±0.03	R
JMK063 BJ683□P-F			X5R	X5R	68000 p	±10, ±20	10	150	0.3±0.03	R
JMK063 BJ104□P-F		6.3	X5R	X5R	0.1 μ	±10, ±20	10	150	0.3±0.03	R
JMK063 BJ224□P-F			X5R	X5R	0.22 μ	±10, ±20	10	150	0.3±0.03	R
JMK063 BJ474□P-F			X5R	X5R	0.47 μ	±10, ±20	10	150	0.3±0.03	R
JMK063ABJ105MP-F			X5R	X5R	1 μ	±20	10	150	0.3±0.05	R
AMK063 BJ224□P-F			X5R	X5R	0.22 μ	±10, ±20	10	150	0.3±0.03	R
AMK063 BJ474MP-F			X5R	X5R	0.47 μ	±20	10	150	0.3±0.03	R
AMK063ABJ105MP-F			X5R	X5R	1 μ	±20	10	150	0.3±0.05	R

【温度特性 C6 : X6S】厚度 0.3mm (P)

型号1	型号2	额定电压 [V]	温度特性		静电容量 [F]	静电容量允许偏差 [%]	tan δ [%]	高温负载	厚度*3 [mm]	焊接方式 R:回流焊 W:波峰焊	
								额定电压 x %			
LMK063 C6333□P-F		10		X6S	33000 p	±10, ±20	7.5	150	0.3±0.03	R	
LMK063 C6473□P-F			X6S	X6S	47000 p	±10, ±20	7.5	150	0.3±0.03	R	
LMK063 C6683□P-F			X6S	X6S	68000 p	±10, ±20	10	150	0.3±0.03	R	
LMK063 C6104□P-F			X6S	X6S	0.1 μ	±10, ±20	10	150	0.3±0.03	R	
LMK063 C6224□P-F			X6S	X6S	0.22 μ	±10, ±20	10	150	0.3±0.03	R	
JMK063 C6333□P-F			6.3	X6S	X6S	33000 p	±10, ±20	7.5	150	0.3±0.03	R
JMK063 C6473□P-F				X6S	X6S	47000 p	±10, ±20	7.5	150	0.3±0.03	R
JMK063 C6683□P-F				X6S	X6S	68000 p	±10, ±20	10	150	0.3±0.03	R
JMK063 C6104□P-F				X6S	X6S	0.1 μ	±10, ±20	10	150	0.3±0.03	R
JMK063 C6224□P-F				X6S	X6S	0.22 μ	±10, ±20	10	150	0.3±0.03	R
AMK063 C6474MP-F		4		X6S	X6S	0.47 μ	±20	10	150	0.3±0.03	R
AMK063AC6105MP-F				X6S	X6S	1 μ	±20	10	150	0.3±0.05	R

【温度特性 B7 : X7R】厚度 0.3mm (P)

型号1	型号2	额定电压 [V]	温度特性		静电容量 [F]	静电容量允许偏差 [%]	tan δ [%]	高温负载	厚度*3 [mm]	焊接方式 R:回流焊 W:波峰焊	
								额定电压 x %			
UMK063 B7101□P-F		50		X7R	100 p	±10, ±20	3.5	200	0.3±0.03	R	
UMK063 B7151□P-F			X7R	X7R	150 p	±10, ±20	3.5	200	0.3±0.03	R	
UMK063 B7221□P-F			X7R	X7R	220 p	±10, ±20	3.5	200	0.3±0.03	R	
UMK063 B7331□P-F			X7R	X7R	330 p	±10, ±20	3.5	200	0.3±0.03	R	
UMK063 B7471□P-F			X7R	X7R	470 p	±10, ±20	3.5	200	0.3±0.03	R	
UMK063 B7681□P-F			X7R	X7R	680 p	±10, ±20	3.5	200	0.3±0.03	R	
UMK063 B7102□P-F			X7R	X7R	1000 p	±10, ±20	3.5	200	0.3±0.03	R	
TMK063 B7152□P-F			25	X7R	X7R	1500 p	±10, ±20	5	200	0.3±0.03	R
TMK063 B7222□P-F				X7R	X7R	2200 p	±10, ±20	5	200	0.3±0.03	R
TMK063 B7332□P-F				X7R	X7R	3300 p	±10, ±20	5	200	0.3±0.03	R
TMK063 B7472□P-F		X7R		X7R	4700 p	±10, ±20	5	200	0.3±0.03	R	
TMK063 B7682□P-F		X7R		X7R	6800 p	±10, ±20	5	200	0.3±0.03	R	
TMK063 B7103□P-F		X7R		X7R	10000 p	±10, ±20	5	200	0.3±0.03	R	
EMK063 B7152□P-F		16		X7R	X7R	1500 p	±10, ±20	5	200	0.3±0.03	R
EMK063 B7222□P-F				X7R	X7R	2200 p	±10, ±20	5	200	0.3±0.03	R
EMK063 B7332□P-F				X7R	X7R	3300 p	±10, ±20	5	200	0.3±0.03	R
EMK063 B7472□P-F				X7R	X7R	4700 p	±10, ±20	5	200	0.3±0.03	R
EMK063 B7682□P-F			X7R	X7R	6800 p	±10, ±20	5	200	0.3±0.03	R	
EMK063 B7103□P-F			X7R	X7R	10000 p	±10, ±20	5	200	0.3±0.03	R	
EMK063 B7223□P-F			X7R	X7R	22000 p	±10, ±20	7.5	150	0.3±0.03	R	

●105型

【温度特性 BJ : B/X5R】厚度 0.5mm (V)

型号1	型号2	额定电压 [V]	温度特性		静电容量 [F]	静电容量允许偏差 [%]	tan δ [%]	高温负载	厚度*3 [mm]	焊接方式 R:回流焊 W:波峰焊
								额定电压 x %		
UMK105 BJ221□V-F		50	B	X5R ⁺¹	220 p	±10, ±20	2.5	200	0.5±0.05	R
UMK105 BJ331□V-F			B	X5R ⁺¹	330 p	±10, ±20	2.5	200	0.5±0.05	R
UMK105 BJ471□V-F			B	X5R ⁺¹	470 p	±10, ±20	2.5	200	0.5±0.05	R
UMK105 BJ681□V-F			B	X5R ⁺¹	680 p	±10, ±20	2.5	200	0.5±0.05	R
UMK105 BJ102□V-F			B	X5R ⁺¹	1000 p	±10, ±20	2.5	200	0.5±0.05	R
UMK105 BJ152□V-F			B	X5R ⁺¹	1500 p	±10, ±20	2.5	200	0.5±0.05	R
UMK105 BJ222□V-F			B	X5R ⁺¹	2200 p	±10, ±20	2.5	200	0.5±0.05	R
UMK105 BJ332□V-F			B	X5R ⁺¹	3300 p	±10, ±20	2.5	200	0.5±0.05	R
UMK105 BJ472□V-F			B	X5R ⁺¹	4700 p	±10, ±20	2.5	200	0.5±0.05	R
UMK105 BJ682□V-F			B	X5R ⁺¹	6800 p	±10, ±20	2.5	150	0.5±0.05	R
UMK105 BJ103□V-F		35	B	X5R ⁺¹	10000 p	±10, ±20	3.5	200	0.5±0.05	R
UMK105 BJ104□V-F			X5R	X5R	0.1 μ	±10, ±20	10	150	0.5±0.05	R
UMK105 BJ224□V-F			X5R	X5R	0.22 μ	±10, ±20	10	150	0.5±0.05	R
UMK105ABJ474□V-F			X5R	X5R	0.47 μ	±10, ±20	10	150	0.5±0.10	R
GMK105 BJ104□V-F			B	X5R	0.1 μ	±10, ±20	5	150	0.5±0.05	R
TMK105 BJ153□V-F			B	X5R ⁺¹	15000 p	±10, ±20	3.5	200	0.5±0.05	R
TMK105 BJ223□V-F			B	X5R ⁺¹	22000 p	±10, ±20	3.5	200	0.5±0.05	R
TMK105 BJ333□V-F			B	X5R ⁺¹	33000 p	±10, ±20	3.5	150	0.5±0.05	R
TMK105 BJ473□V-F			B	X5R ⁺¹	47000 p	±10, ±20	3.5	150	0.5±0.05	R
TMK105 BJ104□V-F			B	X5R	0.1 μ	±10, ±20	5	150	0.5±0.05	R
TMK105 BJ224□V-F		25	X5R	X5R	0.22 μ	±10, ±20	10	200	0.5±0.05	R
TMK105ABJ474□V-F			X5R	X5R	0.47 μ	±10, ±20	10	200	0.5±0.10	R
TMK105 BJ105□V-F			X5R	X5R	1 μ	±10, ±20	10	150	0.5±0.05	R
TMK105CBJ225MV-F			X5R	X5R	2.2 μ	±20	10	150	0.5±0.20/-0	R

▶ 本产品目录根据版面大小, 仅记载了代表性产品规格, 若考虑使用本公司产品时, 请确认供货规格型号明细表中的详细规格。
有关各商品的详细信息(特性图、可靠性信息、使用时的注意事项等), 请参阅本公司网站(<http://www.ty-top.com/>)。

型号1	型号2	额定电压[V]	温度特性		静电容量 [F]	静电容量允许偏差 [%]	tan δ [%]	高温负载	厚度*3 [mm]	焊接方式 R:回流焊 W:波峰焊	
								额定电压 x %			
EMK105 BJ153□V-F		16	B	X5R ⁺	15000 p	±10, ±20	3.5	200	0.5±0.05	R	
EMK105 BJ223□V-F			B	X5R ⁺	22000 p	±10, ±20	3.5	200	0.5±0.05	R	
EMK105 BJ333□V-F			B	X5R ⁺	33000 p	±10, ±20	3.5	200	0.5±0.05	R	
EMK105 BJ473□V-F			B	X5R ⁺	47000 p	±10, ±20	3.5	200	0.5±0.05	R	
EMK105 BJ683□V-F			B	X5R	68000 p	±10, ±20	5	200	0.5±0.05	R	
EMK105 BJ104□V-F			B	X5R ⁺	0.1 μ	±10, ±20	5	150	0.5±0.05	R	
EMK105 BJ224□V-F			B	X5R	0.22 μ	±10, ±20	5	150	0.5±0.05	R	
EMK105ABJ474□V-F				X5R	0.47 μ	±10, ±20	10	150	0.5±0.10	R	
EMK105 BJ105□V-F				X5R	1 μ	±10, ±20	10	150	0.5±0.05	R	
EMK105ABJ225MV-F				X5R	2.2 μ	±20	10	150	0.5±0.10	R	
LMK105 BJ104□V-F			10	B	X5R	0.1 μ	±10, ±20	5	200	0.5±0.05	R
LMK105 BJ224□V-F				B	X5R	0.22 μ	±10, ±20	5	150	0.5±0.05	R
LMK105 BJ474□V-F					X5R	0.47 μ	±10, ±20	10	150	0.5±0.05	R
LMK105 BJ105□V-F					X5R	1 μ	±10, ±20	10	150	0.5±0.05	R
LMK105 BJ225MV-F					X5R	2.2 μ	±20	10	150	0.5±0.05	R
LMK105BBJ475MVLF					X5R	4.7 μ	±20	10	150	0.5+0.15/-0.05	R
JMK105 BJ224□V-F		6.3		B	X5R	0.22 μ	±10, ±20	5	150	0.5±0.05	R
JMK105 BJ474□V-F					X5R	0.47 μ	±10, ±20	10	150	0.5±0.05	R
JMK105 BJ105□V-F					X5R	1 μ	±10, ±20	10	150	0.5±0.05	R
JMK105 BJ225MV-F					X5R	2.2 μ	±20	10	150	0.5±0.05	R
JMK105BBJ475MV-F	JMK105 BJ475MV-FD			X5R	4.7 μ	±20	10	150	0.5+0.15/-0.05	R	
AMK105 BJ335MV-F			4	X5R	3.3 μ	±20	10	150	0.5±0.05	R	
AMK105ABJ475MV-F	AMK105 BJ475MV-F			X5R	4.7 μ	±20	10	150	0.5±0.10	R	
AMK105CBJ106MV-F				X5R	10 μ	±20	10	150	0.5+0.20/-0	R	

【温度特性 BJ: X5R】 厚度 0.3mm(P)

型号1	型号2	额定电压[V]	温度特性		静电容量 [F]	静电容量允许偏差 [%]	tan δ [%]	高温负载	厚度*3 [mm]	焊接方式 R:回流焊 W:波峰焊
								额定电压 x %		
TMK105 BJ103□P-F		25	B	X5R	10000 p	±10, ±20	5	150	0.3±0.03	R
TMK105 BJ104□P-F				X5R	0.1 μ	±10, ±20	10	150	0.3±0.03	R
TMK105 BJ224□P-F				X5R	0.22 μ	±10, ±20	10	150	0.3±0.03	R
TMK105 BJ474□P-F				X5R	0.47 μ	±10, ±20	10	150	0.3±0.03	R
EMK105 BJ474□P-F		16	X5R	0.47 μ	±10, ±20	10	150	0.3±0.03	R	
LMK105 BJ105□PLF		10	X5R	1 μ	±10, ±20	10	150	0.3±0.03	R	
JMK105 BJ105□P-F		6.3	X5R	1 μ	±10, ±20	10	150	0.3±0.03	R	
AMK105 BJ225MP-F		4	X5R	2.2 μ	±20	10	150	0.3±0.03	R	

【温度特性 BJ: X5R】 厚度 0.2mm(C)

型号1	型号2	额定电压[V]	温度特性		静电容量 [F]	静电容量允许偏差 [%]	tan δ [%]	高温负载	厚度*3 [mm]	焊接方式 R:回流焊 W:波峰焊
								额定电压 x %		
LMK105 BJ104□C-F		10	X5R	0.1 μ	±10, ±20	10	150	0.2±0.02	R	
JMK105 BJ224□C-F			X5R	0.22 μ	±10, ±20	10	150	0.2±0.02	R	
JMK105 BJ474□C-F		6.3	X5R	0.47 μ	±10, ±20	10	150	0.2±0.02	R	
JMK105 BJ105MC-F			X5R	1 μ	±20	10	150	0.2±0.02	R	

【温度特性 C6: X6S】 厚度 0.5mm(V)

型号1	型号2	额定电压[V]	温度特性		静电容量 [F]	静电容量允许偏差 [%]	tan δ [%]	高温负载	厚度*3 [mm]	焊接方式 R:回流焊 W:波峰焊
								额定电压 x %		
EMK105 C6105□V-F		16	X6S	1 μ	±10, ±20	10	150	0.5±0.05	R	
EMK105CC6225MV-F			X6S	2.2 μ	±20	10	150	0.5+0.20/-0	R	
LMK105 C6105□V-F		10	X6S	1 μ	±10, ±20	10	200	0.5±0.05	R	
LMK105AC6225MV-F			X6S	2.2 μ	±20	10	150	0.5±0.10	R	
JMK105 C6105□V-F		6.3	X6S	1 μ	±10, ±20	10	150	0.5±0.05	R	
JMK105 C6225MV-F			X6S	2.2 μ	±20	10	150	0.5±0.05	R	
JMK105BC6475MV-F			X6S	4.7 μ	±20	10	150	0.5+0.15/-0.05	R	
AMK105BC6475MV-F			4	X6S	4.7 μ	±20	10	150	0.5+0.15/-0.05	R

【温度特性 B7: X7R】 厚度 0.5mm(V)

型号1	型号2	额定电压[V]	温度特性		静电容量 [F]	静电容量允许偏差 [%]	tan δ [%]	高温负载	厚度*3 [mm]	焊接方式 R:回流焊 W:波峰焊	
								额定电压 x %			
UMK105 B7221□V-F		50	X7R	220 p	±10, ±20	2.5	200	0.5±0.05	R		
UMK105 B7331□V-F			X7R	330 p	±10, ±20	2.5	200	0.5±0.05	R		
UMK105 B7471□V-F			X7R	470 p	±10, ±20	2.5	200	0.5±0.05	R		
UMK105 B7681□V-F			X7R	680 p	±10, ±20	2.5	200	0.5±0.05	R		
UMK105 B7102□V-F			X7R	1000 p	±10, ±20	2.5	200	0.5±0.05	R		
UMK105 B7152□V-F			X7R	1500 p	±10, ±20	2.5	200	0.5±0.05	R		
UMK105 B7222□V-F			X7R	2200 p	±10, ±20	2.5	200	0.5±0.05	R		
UMK105 B7332□V-F			X7R	3300 p	±10, ±20	2.5	200	0.5±0.05	R		
UMK105 B7472□V-F			X7R	4700 p	±10, ±20	2.5	200	0.5±0.05	R		
UMK105 B7682□V-F			X7R	6800 p	±10, ±20	2.5	200	0.5±0.05	R		
UMK105 B7103□V-F			X7R	10000 p	±10, ±20	3.5	200	0.5±0.05	R		
UMK105 B7104□V-FR			X7R	0.1 μ	±10, ±20	10	150	0.5±0.05	R		
TMK105 B7152□V-F			25	X7R	1500 p	±10, ±20	2.5	200	0.5±0.05	R	
TMK105 B7222□V-F				X7R	2200 p	±10, ±20	2.5	200	0.5±0.05	R	
TMK105 B7332□V-F				X7R	3300 p	±10, ±20	2.5	200	0.5±0.05	R	
TMK105 B7472□V-F				X7R	4700 p	±10, ±20	2.5	200	0.5±0.05	R	
TMK105 B7682□V-F				X7R	6800 p	±10, ±20	2.5	200	0.5±0.05	R	
TMK105 B7103□V-F				X7R	10000 p	±10, ±20	3.5	200	0.5±0.05	R	
TMK105 B7104□V-FR				X7R	0.1 μ	±10, ±20	10	200	0.5±0.05	R	
TMK105 B7224□V-FR				X7R	0.22 μ	±10, ±20	10	150	0.5±0.05	R	
EMK105 B7223□V-F				16	X7R	22000 p	±10, ±20	3.5	200	0.5±0.05	R
EMK105 B7473□V-F					X7R	47000 p	±10, ±20	3.5	200	0.5±0.05	R
EMK105 B7104□V-F			X7R		0.1 μ	±10, ±20	5	150	0.5±0.05	R	
EMK105 B7224□V-FR			X7R		0.22 μ	±10, ±20	10	150	0.5±0.05	R	

▶ 本产品目录根据版面大小, 仅记载了代表性产品规格, 若考虑使用本公司产品时, 请确认供货规格型号明细表中的详细规格。
有关各商品的详细信息(特性图、可靠性信息、使用时的注意事项等), 请参阅本公司网站(<http://www.ty-top.com/>)。

型号1	型号2	额定电压 [V]	温度特性		静电容量 [F]	静电容量允许偏差 [%]	tan δ [%]	高温负载	厚度*3 [mm]	焊接方式 R:回流焊 W:波峰焊
								额定电压 x %		
LMK105 B7223[V]-F		10		X7R	22000 p	±10, ±20	3.5	200	0.5±0.05	R
LMK105 B7473[V]-F					47000 p	±10, ±20	3.5	200	0.5±0.05	R
LMK105 B7104[V]-F					0.1 μ	±10, ±20	5	150	0.5±0.05	R
LMK105 B7224[V]-FR					0.22 μ	±10, ±20	10	150	0.5±0.05	R
LMK105 B7474[V]-F					0.47 μ	±10, ±20	10	150	0.5±0.05	R
JMK105 B7224[V]-F		6.3		X7R	0.22 μ	±10, ±20	5	150	0.5±0.05	R
JMK105 B7474[V]-F					0.47 μ	±10, ±20	10	150	0.5±0.05	R

【温度特性 F: F/Y5V】厚度 0.5mm(V)

型号1	型号2	额定电压 [V]	温度特性		静电容量 [F]	静电容量允许偏差 [%]	tan δ [%]	高温负载	厚度*3 [mm]	焊接方式 R:回流焊 W:波峰焊
								额定电压 x %		
UMK105 F1032V-F		50	F	Y5V	10000 p	+80/-20	5	200	0.5±0.05	R
TMK105 F2232V-F		25	F	Y5V	22000 p	+80/-20	5	200	0.5±0.05	R
EMK105 F4732V-F		16	F	Y5V	47000 p	+80/-20	7	200	0.5±0.05	R
EMK105 F1042V-F					0.1 μ	+80/-20	9	200	0.5±0.05	R
LMK105 F2242V-F		10	F	Y5V	0.22 μ	+80/-20	11	200	0.5±0.05	R
JMK105 F4742V-F					0.47 μ	+80/-20	12.5	200	0.5±0.05	R
JMK105 F1052V-F		6.3	F	Y5V	1 μ	+80/-20	20	150	0.5±0.05	R

●107型

【温度特性 BJ: B/X5R】厚度 0.8mm(A)

型号1	型号2	额定电压 [V]	温度特性		静电容量 [F]	静电容量允许偏差 [%]	tan δ [%]	高温负载	厚度*3 [mm]	焊接方式 R:回流焊 W:波峰焊
								额定电压 x %		
UMK107ABJ474[A]-T	UMK107 BJ474[A]-TD	50		X5R	0.47 μ	±10, ±20	10	150	0.8±0.15/-0.05	R
UMK107 BJ105[A]-T					1 μ	±10, ±20	10	150	0.8±0.10	R
UMK107BBJ225[A]-T					2.2 μ	±10, ±20	10	150	0.8±0.20/-0	R
GMK107 BJ105[A]-T		35	B	X5R	1 μ	±10, ±20	5	150	0.8±0.10	R
TMK107 BJ224[A]-T					0.22 μ	±10, ±20	3.5	200	0.8±0.10	R/W
TMK107 BJ474[A]-T		25	B	X5R	0.47 μ	±10, ±20	3.5	150	0.8±0.10	R
TMK107 BJ105[A]-T					1 μ	±10, ±20	5	150	0.8±0.10	R
TMK107ABJ225[A]-T	TMK107 BJ225[A]-TD				2.2 μ	±10, ±20	10	150	0.8±0.15/-0.05	R
EMK107 BJ224[A]-T		16	B	X5R ¹⁾	0.22 μ	±10, ±20	3.5	200	0.8±0.10	R/W
EMK107 BJ474[A]-T					0.47 μ	±10, ±20	3.5	200	0.8±0.10	R
EMK107 BJ105[A]-T					1 μ	±10, ±20	5	150	0.8±0.10	R
EMK107 BJ225[A]-T		10	B	X5R	2.2 μ	±10, ±20	10	150	0.8±0.10	R
EMK107ABJ475[A]-T	EMK107 BJ475[A]-TD				4.7 μ	±10, ±20	10	150	0.8±0.15/-0.05	R
EMK107BBJ106MA-T					10 μ	±20	10	150	0.8±0.20/-0	R
LMK107 BJ224[A]-T		10	B	X5R ¹⁾	0.22 μ	±10, ±20	3.5	200	0.8±0.10	R/W
LMK107 BJ474[A]-T					0.47 μ	±10, ±20	3.5	200	0.8±0.10	R
LMK107 BJ105[A]-T					1 μ	±10, ±20	5	200	0.8±0.10	R
LMK107 BJ225[A]-T		10	B	X5R	2.2 μ	±10, ±20	10	150	0.8±0.10	R
LMK107 BJ475[A]-T					4.7 μ	±10, ±20	10	150	0.8±0.10	R
LMK107BBJ106MALT	LMK107 BJ106MALT				10 μ	±20	10	150	0.8±0.20/-0	R
JMK107 BJ225[A]-T		6.3	B	X5R	2.2 μ	±10, ±20	10	150	0.8±0.10	R
JMK107 BJ475[A]-T					4.7 μ	±10, ±20	10	150	0.8±0.10	R
JMK107ABJ106MA-T	JMK107 BJ106MA-T				10 μ	±20	10	150	0.8±0.15/-0.05	R
AMK107 BJ106MA-T		4		X5R	10 μ	±20	10	150	0.8±0.10	R
AMK107BBJ226MA-T	AMK107 BJ226MA-T				22 μ	±20	10	150	0.8±0.20/-0	R

【温度特性 BJ: B/X5R】厚度 0.45mm(K)

型号1	型号2	额定电压 [V]	温度特性		静电容量 [F]	静电容量允许偏差 [%]	tan δ [%]	高温负载	厚度*3 [mm]	焊接方式 R:回流焊 W:波峰焊
								额定电压 x %		
TMK107 BJ105[K]-T		25		X5R	1 μ	±10, ±20	10	150	0.45±0.05	R
EMK107 BJ105[K]-T		16		X5R	1 μ	±10, ±20	10	150	0.45±0.05	R
EMK107BBJ225[K]-T					2.2 μ	±10, ±20	10	150	0.45±0.05	R
LMK107 BJ105[K]-T		10	B	X5R	1 μ	±10, ±20	10	150	0.45±0.05	R
LMK107 BJ225[K]-T					2.2 μ	±10, ±20	10	150	0.45±0.05	R
LMK107BBJ475MKLT	LMK107 BJ475MKLT				4.7 μ	±20	10	150	0.45±0.05	R
JMK107 BJ105[K]-T		6.3	B	X5R	1 μ	±10, ±20	10	150	0.45±0.05	R
JMK107 BJ225[K]-T					2.2 μ	±10, ±20	10	150	0.45±0.05	R
JMK107 BJ475MK-T					4.7 μ	±20	10	150	0.45±0.05	R
JMK107BBJ106MK-T		4		X5R	10 μ	±20	10	150	0.45±0.05	R
AMK107BBJ106MK-T					10 μ	±20	10	150	0.45±0.05	R

【温度特性 C6: X6S】厚度 0.8mm(A)

型号1	型号2	额定电压 [V]	温度特性		静电容量 [F]	静电容量允许偏差 [%]	tan δ [%]	高温负载	厚度*3 [mm]	焊接方式 R:回流焊 W:波峰焊
								额定电压 x %		
EMK107 C6105[A]-T		16		X6S	1 μ	±10, ±20	5	150	0.8±0.10	R
LMK107 C6105[A]-T					1 μ	±10, ±20	5	150	0.8±0.10	R
LMK107AC6475[A]-T					4.7 μ	±10, ±20	10	150	0.8±0.15/-0.05	R
LMK107BC6106MA-T		10		X6S	10 μ	±20	10	150	0.8±0.20/-0	R
JMK107 C6105[A]-T					1 μ	±10, ±20	5	150	0.8±0.10	R
JMK107 C6475[A]-T					4.7 μ	±10, ±20	10	150	0.8±0.10	R
JMK107BC6106MA-T		6.3		X6S	10 μ	±20	10	150	0.8±0.20/-0	R
AMK107AC6106MA-T					10 μ	±20	10	150	0.8±0.15/-0.05	R

【温度特性 B7: X7R】厚度 0.8mm(A)

型号1	型号2	额定电压 [V]	温度特性		静电容量 [F]	静电容量允许偏差 [%]	tan δ [%]	高温负载	厚度*3 [mm]	焊接方式 R:回流焊 W:波峰焊
								额定电压 x %		
UMK107 B7224[A]-TR		50		X7R	0.22 μ	±10, ±20	10	150	0.8±0.10	R
UMK107 B7474[A]-TR					0.47 μ	±10, ±20	10	150	0.8±0.10	R
UMK107AB7105[A]-T					1 μ	±10, ±20	10	150	0.8±0.15/-0.05	R
TMK107 B7474[A]-TR		25		X7R	0.47 μ	±10, ±20	10	150	0.8±0.10	R
TMK107 B7105[A]-T					1 μ	±10, ±20	10	150	0.8±0.10	R

▶ 本产品目录根据版面大小, 仅记载了代表性产品规格, 若考虑使用本公司产品时, 请确认供货规格型号明细表中的详细规格。
有关各商品的详细信息(特性图、可靠性信息、使用时的注意事项等), 请参阅本公司网站(<http://www.ty-top.com/>)。

■ 型号一览

型号1	型号2	额定电压[V]	温度特性		静电容量 [F]	静电容量允许偏差 [%]	tan δ [%]	高温负载	厚度*3 [mm]	焊接方式 R:回流焊 W:波峰焊
								额定电压 x %		
EMK107 B7224□A-T		16	X7R		0.22 μ	±10, ±20	3.5	150	0.8±0.10	R/W
EMK107 B7474□A-T					0.47 μ	±10, ±20	3.5	150	0.8±0.10	R
EMK107 B7105□A-T					1 μ	±10, ±20	5	150	0.8±0.10	R
EMK107BB7225□A-T					X7R	2.2 μ	±10, ±20	10	150	0.8+0.20/-0
LMK107 B7224□A-T		10	X7R		0.22 μ	±10, ±20	3.5	200	0.8±0.10	R/W
LMK107 B7474□A-T					0.47 μ	±10, ±20	3.5	200	0.8±0.10	R
LMK107 B7105□A-T					1 μ	±10, ±20	5	150	0.8±0.10	R
LMK107 B7225□A-TR					X7R	2.2 μ	±10, ±20	10	150	0.8±0.10
JMK107 B7224□A-T		6.3	X7R		0.22 μ	±10, ±20	3.5	200	0.8±0.10	R/W
JMK107 B7474□A-T					0.47 μ	±10, ±20	3.5	200	0.8±0.10	R
JMK107 B7105□A-T					1 μ	±10, ±20	5	150	0.8±0.10	R

【温度特性 F: F/Y5V】厚度 0.8mm(A)

型号1	型号2	额定电压[V]	温度特性		静电容量 [F]	静电容量允许偏差 [%]	tan δ [%]	高温负载	厚度*3 [mm]	焊接方式 R:回流焊 W:波峰焊
								额定电压 x %		
UMK107 F104ZA-T		50	F	Y5V	0.1 μ	+80/-20	7	200	0.8±0.10	R/W
TMK107 F474ZA-T		25	F	Y5V	0.47 μ	+80/-20	7	200	0.8±0.10	R/W
EMK107 F224ZA-T		16	F	Y5V	0.22 μ	+80/-20	7	200	0.8±0.10	R/W
EMK107 F474ZA-T					0.47 μ	+80/-20	7	200	0.8±0.10	R/W
EMK107 F105ZA-T					1 μ	+80/-20	16	200	0.8±0.10	R
EMK107 F225ZA-T					2.2 μ	+80/-20	16	200	0.8±0.10	R
LMK107 F105ZA-T		10	F	Y5V	1 μ	+80/-20	16	200	0.8±0.10	R
LMK107 F225ZA-T					2.2 μ	+80/-20	16	200	0.8±0.10	R

● 212型

【温度特性 BJ: B/X5R】厚度 1.25mm(G)

型号1	型号2	额定电压[V]	温度特性		静电容量 [F]	静电容量允许偏差 [%]	tan δ [%]	高温负载	厚度*3 [mm]	焊接方式 R:回流焊 W:波峰焊	
								额定电压 x %			
UMK212 BJ104□G-T		50	B	X5R ⁺	0.1 μ	±10, ±20	3.5	200	1.25±0.10	R/W	
UMK212 BJ224□G-T					0.22 μ	±10, ±20	3.5	200	1.25±0.10	R/W	
UMK212 BJ474□G-T					0.47 μ	±10, ±20	3.5	150	1.25±0.10	R/W	
UMK212 BJ105□G-T					1 μ	±10, ±20	5	150	1.25±0.10	R/W	
UMK212ABJ225□G-T					X5R	2.2 μ	±10, ±20	10	150	1.25+0.15/-0.05	R
UMK212BBJ475□G-T					X5R	4.7 μ	±10, ±20	10	150	1.25+0.20/-0	R
TMK212 BJ225□G-T		25	B	X5R	2.2 μ	±10, ±20	5	150	1.25±0.10	R	
TMK212ABJ475□G-T	TMK212 BJ475□G-T				X5R	4.7 μ	±10, ±20	10	150	1.25+0.15/-0.05	R
TMK212BBJ106MG-T		16	B	X5R ⁺	10 μ	±20	10	150	1.25+0.20/-0	R	
EMK212 BJ225□G-T					2.2 μ	±10, ±20	5	200	1.25±0.10	R	
EMK212ABJ475□G-T	EMK212 BJ475□G-T				X5R ⁺	4.7 μ	±10, ±20	5	150	1.25+0.15/-0.05	R
EMK212ABJ106□G-T	EMK212 BJ106□G-T				X5R	10 μ	±10, ±20	10	150	1.25+0.15/-0.05	R
EMK212BBJ226MG-T					X5R	22 μ	±20	10	150	1.25+0.20/-0	R
LMK212 BJ225□G-T					10	B	X5R ⁺	2.2 μ	±10, ±20	5	200
LMK212ABJ475□G-T	LMK212 BJ475□G-T	X5R ⁺	4.7 μ	±10, ±20				5	200	1.25+0.15/-0.05	R
LMK212ABJ106□G-T	LMK212 BJ106□G-T	X5R	10 μ	±10, ±20				10	200	1.25+0.15/-0.05	R
LMK212BBJ226MG-T	LMK212 BJ226MG-T	X5R	22 μ	±20				10	150	1.25+0.20/-0	R
JMK212ABJ475□G-T	JMK212 BJ475□G-T	B	4.7 μ	±10, ±20				5	200	1.25+0.15/-0.05	R
JMK212ABJ106□G-T	JMK212 BJ106□G-T	X5R ⁺	10 μ	±10, ±20				10	200	1.25+0.15/-0.05	R
JMK212ABJ226MG-T	JMK212 BJ226MG-T	6.3	X5R		22 μ	±20	10	150	1.25+0.15/-0.05	R	
JMK212BBJ476MG-T	JMK212 BJ476MG-T				4.7 μ	±20	10	150	1.25+0.20/-0	R	

【温度特性 BJ: B/X5R】厚度 0.85mm(D)

型号1	型号2	额定电压[V]	温度特性		静电容量 [F]	静电容量允许偏差 [%]	tan δ [%]	高温负载	厚度*3 [mm]	焊接方式 R:回流焊 W:波峰焊	
								额定电压 x %			
UMK212ABJ105□D-T	UMK212 BJ105□D-TD	50		X5R	1 μ	±10, ±20	10	150	0.85±0.10	R	
UMK212BBJ225□D-T					2.2 μ	±10, ±20	10	150	0.85±0.10	R	
TMK212 BJ474□D-T		25	B	X5R	0.47 μ	±10, ±20	3.5	200	0.85±0.10	R	
TMK212 BJ105□D-T					1 μ	±10, ±20	5	200	0.85±0.10	R	
TMK212ABJ225□D-T	TMK212 BJ225□D-T				X5R	2.2 μ	±10, ±20	5	150	0.85±0.10	R
TMK212BBJ475□D-T	TMK212 BJ475□D-TD				X5R	4.7 μ	±10, ±20	10	150	0.85±0.10	R
EMK212 BJ105□D-T		16	B	X5R ⁺	1 μ	±10, ±20	5	200	0.85±0.10	R	
EMK212ABJ225□D-T	EMK212 BJ225□D-T				2.2 μ	±10, ±20	5	150	0.85±0.10	R	
EMK212 BJ475□D-T					X5R	4.7 μ	±10, ±20	10	150	0.85±0.10	R
EMK212ABJ106□D-T	EMK212 BJ106□D-TD				X5R	10 μ	±10, ±20	10	150	0.85±0.10	R
LMK212 BJ105□D-T		10	B	X5R ⁺	1 μ	±10, ±20	3.5	200	0.85±0.10	R	
LMK212 BJ225□D-T					2.2 μ	±10, ±20	5	200	0.85±0.10	R	
LMK212 BJ475□D-T					X5R	4.7 μ	±10, ±20	10	200	0.85±0.10	R
LMK212ABJ106□D-T	LMK212 BJ106□D-T				X5R	10 μ	±10, ±20	10	150	0.85±0.10	R
LMK212BBJ226MD-T					X5R	22 μ	±20	10	150	0.85±0.10	R
JMK212 BJ475□D-T					X5R	4.7 μ	±10, ±20	10	200	0.85±0.10	R
JMK212ABJ106□D-T	JMK212 BJ106□D-T	6.3	X5R		10 μ	±10, ±20	10	200	0.85±0.10	R	
JMK212ABJ226MD-T	JMK212 BJ226MD-T				22 μ	±20	10	150	0.85±0.10	R	
AMK212BBJ476MD-T		4	X5R		4.7 μ	±20	10	150	0.85±0.10	R	

【温度特性 BJ: X5R】厚度 0.45mm(K)

型号1	型号2	额定电压[V]	温度特性		静电容量 [F]	静电容量允许偏差 [%]	tan δ [%]	高温负载	厚度*3 [mm]	焊接方式 R:回流焊 W:波峰焊
								额定电压 x %		
LMK212ABJ475□K-T	LMK212 BJ475□K-T	10		X5R	4.7 μ	±10, ±20	10	150	0.45±0.05	R
JMK212ABJ475□K-T	JMK212 BJ475□K-T	6.3		X5R	4.7 μ	±10, ±20	10	150	0.45±0.05	R
JMK212ABJ106MK-T #2	JMK212 BJ106MK-T				10 μ	±20	10	150	0.45±0.05	R

▶ 本产品目录根据版面大小，仅记载了代表性产品规格，若考虑使用本公司产品时，请确认供货规格型号明细表中的详细规格。有关各商品的详细信息(特性图、可靠性信息、使用时的注意事项等)，请参阅本公司网站(<http://www.ty-top.com/>)。

●型号一览

【温度特性 C6 : X6S】厚度 1.25mm(G)

型号1	型号2	额定电压 [V]	温度特性		静电容量 [F]	静电容量允许偏差 [%]	tan δ [%]	高温负载	厚度*3 [mm]	焊接方式 R:回流焊 W:波峰焊
								额定电压 x %		
LMK212BC6226MG-T		10		X6S	22 μ	±20	10	150	1.25±0.20/-0	R
JMK212BC6226MG-T		6.3		X6S	22 μ	±20	10	150	1.25±0.20/-0	R
AMK212AC6226MG-T		4		X6S	22 μ	±20	10	150	1.25±0.15/-0.05	R
AMK212BC6476MG-T			X6S	47 μ	±20	10	150	1.25±0.20/-0	R	

【温度特性 C6 : X6S】厚度 0.85mm(D)

型号1	型号2	额定电压 [V]	温度特性		静电容量 [F]	静电容量允许偏差 [%]	tan δ [%]	高温负载	厚度*3 [mm]	焊接方式 R:回流焊 W:波峰焊
								额定电压 x %		
LMK212AC6106[D]-T		10		X6S	10 μ	±10, ±20	10	150	0.85±0.10	R

【温度特性 B7 : X7R】厚度 1.25mm(G)

型号1	型号2	额定电压 [V]	温度特性		静电容量 [F]	静电容量允许偏差 [%]	tan δ [%]	高温负载	厚度*3 [mm]	焊接方式 R:回流焊 W:波峰焊
								额定电压 x %		
UMK212 B7104[G]-T		50		X7R	0.1 μ	±10, ±20	3.5	200	1.25±0.10	R/W
UMK212 B7224[G]-T			X7R	0.22 μ	±10, ±20	3.5	150	1.25±0.10	R/W	
UMK212 B7474[G]-T			X7R	0.47 μ	±10, ±20	3.5	150	1.25±0.10	R/W	
UMK212 B7105[G]-T			X7R	1 μ	±10, ±20	10	150	1.25±0.10	R/W	
UMK212BB7225[G]-T			X7R	2.2 μ	±10, ±20	10	150	1.25±0.20/-0	R	
GMK212 B7105[G]-T		35		X7R	1 μ	±10, ±20	3.5	150	1.25±0.10	R/W
TMK212 B7105[G]-T			X7R	1 μ	±10, ±20	3.5	150	1.25±0.10	R	
TMK212 B7225[G]-TR		25		X7R	2.2 μ	±10, ±20	10	150	1.25±0.10	R
TMK212AB7475[G]-T	TMK212 B7475[G]-T		X7R	4.7 μ	±10, ±20	10	150	1.25±0.15/-0.05	R	
EMK212 B7105[G]-T		16		X7R	1 μ	±10, ±20	3.5	200	1.25±0.10	R/W
EMK212 B7225[G]-T			X7R	2.2 μ	±10, ±20	10	150	1.25±0.10	R	
EMK212 B7475[G]-T			X7R	4.7 μ	±10, ±20	10	150	1.25±0.10	R	
EMK212BB7106MG-T			X7R	10 μ	±20	10	150	1.25±0.20/-0	R	
LMK212 B7105[G]-T		10		X7R	1 μ	±10, ±20	3.5	200	1.25±0.10	R/W
LMK212 B7225[G]-T			X7R	2.2 μ	±10, ±20	5	200	1.25±0.10	R	
LMK212 B7475[G]-T			X7R	4.7 μ	±10, ±20	10	150	1.25±0.10	R	
LMK212AB7106MG-T	LMK212 B7106MG-TD		X7R	10 μ	±20	10	150	1.25±0.15/-0.05	R	
JMK212AB7106[G]-T	JMK212 B7106[G]-T	6.3		X7R	10 μ	±10, ±20	10	150	1.25±0.15/-0.05	R

【温度特性 B7 : X7R】厚度 0.85mm(D)

型号1	型号2	额定电压 [V]	温度特性		静电容量 [F]	静电容量允许偏差 [%]	tan δ [%]	高温负载	厚度*3 [mm]	焊接方式 R:回流焊 W:波峰焊
								额定电压 x %		
UMK212AB7104[D]-T		50		X7R	0.1 μ	±10, ±20	10	150	0.85±0.10	R
UMK212AB7224[D]-T			X7R	0.22 μ	±10, ±20	10	150	0.85±0.10	R	
UMK212AB7474[D]-T			X7R	0.47 μ	±10, ±20	10	150	0.85±0.10	R	
UMK212AB7105[D]-T			X7R	1 μ	±10, ±20	10	150	0.85±0.10	R	
TMK212AB7225[D]-TR			X7R	2.2 μ	±10, ±20	10	150	0.85±0.10	R	
EMK212 B7474[D]-T		25		X7R	0.47 μ	±10, ±20	3.5	200	0.85±0.10	R/W
EMK212 B7105[D]-T			X7R	1 μ	±10, ±20	5	200	0.85±0.10	R	
EMK212AB7225[D]-T	EMK212 B7225[D]-T	10		X7R	2.2 μ	±10, ±20	5	150	0.85±0.10	R
LMK212 B7105[D]-T			X7R	1 μ	±10, ±20	3.5	200	0.85±0.10	R	
LMK212AB7225[D]-T	LMK212 B7225[D]-T		X7R	2.2 μ	±10, ±20	5	200	0.85±0.10	R	
LMK212AB7475[D]-TR	LMK212 B7475[D]-TR		X7R	4.7 μ	±10, ±20	10	150	0.85±0.10	R	

【温度特性 F : F/Y5V】厚度 1.25mm(G)

型号1	型号2	额定电压 [V]	温度特性		静电容量 [F]	静电容量允许偏差 [%]	tan δ [%]	高温负载	厚度*3 [mm]	焊接方式 R:回流焊 W:波峰焊
								额定电压 x %		
UMK212 F474ZG-T		50	F	Y5V	0.47 μ	+80/-20	7	200	1.25±0.10	R/W
UMK212 F105ZG-T			F	Y5V	1 μ	+80/-20	7	200	1.25±0.10	R/W
EMK212 F225ZG-T		16	F	Y5V	2.2 μ	+80/-20	7	200	1.25±0.10	R/W
LMK212 F475ZG-T		10	F	Y5V	4.7 μ	+80/-20	9	200	1.25±0.10	R
LMK212 F106ZG-T			F	Y5V	10 μ	+80/-20	16	200	1.25±0.10	R
JMK212 F106ZG-T		6.3	F	Y5V	10 μ	+80/-20	16	200	1.25±0.10	R

【温度特性 F : F/Y5V】厚度 0.85mm(D)

型号1	型号2	额定电压 [V]	温度特性		静电容量 [F]	静电容量允许偏差 [%]	tan δ [%]	高温负载	厚度*3 [mm]	焊接方式 R:回流焊 W:波峰焊
								额定电压 x %		
UMK212 F224ZD-T		50	F	Y5V	0.22 μ	+80/-20	7	200	0.85±0.10	R/W
LMK212 F225ZD-T		10	F	Y5V	2.2 μ	+80/-20	9	200	0.85±0.10	R
JMK212 F475ZD-T		6.3	F	Y5V	4.7 μ	+80/-20	16	200	0.85±0.10	R

●316型

【温度特性 BJ : B/X5R】厚度 1.6mm(L)

型号1	型号2	额定电压 [V]	温度特性		静电容量 [F]	静电容量允许偏差 [%]	tan δ [%]	高温负载	厚度*3 [mm]	焊接方式 R:回流焊 W:波峰焊
								额定电压 x %		
UMK316 BJ105[L]-T		50	B	X5R*1	1 μ	±10, ±20	3.5	200	1.6±0.20	R
UMK316 BJ225[L]-T			X5R	2.2 μ	±10, ±20	10	150	1.6±0.20	R	
UMK316 BJ475[L]-T			X5R	4.7 μ	±10, ±20	10	150	1.6±0.20	R	
UMK316BBJ106ML-T			X5R	10 μ	±20	10	150	1.6±0.30	R	
TMK316 BJ225[L]-T			B	X5R*1	2.2 μ	±10, ±20	3.5	200	1.6±0.20	R
TMK316 BJ475[L]-T		25	B	X5R	4.7 μ	±10, ±20	5	150	1.6±0.20	R
TMK316 BJ106[L]-T			X5R*1	10 μ	±10, ±20	5	150	1.6±0.20	R	
TMK316BBJ226ML-T			X5R	2.2 μ	±20	10	150	1.6±0.30	R	
EMK316 BJ225[L]-T		16	B	X5R*1	2.2 μ	±10, ±20	3.5	200	1.6±0.20	R/W
EMK316 BJ475[L]-T			B	X5R	4.7 μ	±10, ±20	5	200	1.6±0.20	R
EMK316 BJ106[L]-T			B	X5R*1	10 μ	±10, ±20	5	150	1.6±0.20	R
EMK316ABJ226ML-T	EMK316 BJ226ML-T		B	X5R	2.2 μ	±20	10	150	1.6±0.20	R
LMK316 BJ106[L]-T		10	B	X5R*1	10 μ	±10, ±20	5	200	1.6±0.20	R
LMK316ABJ226[L]-T	LMK316 BJ226[L]-T		B	X5R	2.2 μ	±10, ±20	10	150	1.6±0.20	R
LMK316ABJ476ML-T	LMK316 BJ476ML-T		X5R	4.7 μ	±20	10	150	1.6±0.20	R	

▶ 本产品目录根据版面大小, 仅记载了代表性产品规格, 若考虑使用本公司产品时, 请确认供货规格型号明细表中的详细规格。有关各商品的详细信息(特性图、可靠性信息、使用时的注意事项等), 请参阅本公司网站(<http://www.ty-top.com/>)。

■ 型号一览

型号1	型号2	额定电压[V]	温度特性		静电容量 [F]	静电容量允许偏差 [%]	tan δ [%]	高温负载	厚度*3 [mm]	焊接方式 R:回流焊 W:波峰焊
								额定电压 x %		
JMK316 BJ106□L-T		6.3	B	X5R ¹⁾	10 μ	±10, ±20	5	200	1.6±0.20	R
JMK316ABJ226□L-T	JMK316 BJ226□L-T		B	X5R	22 μ	±10, ±20	10	200	1.6±0.20	R
JMK316ABJ476ML-T	JMK316 BJ476ML-T			X5R	47 μ	±20	10	200	1.6±0.20	R
JMK316ABJ107ML-T	JMK316 BJ107ML-T			X5R	100 μ	±20	10	150	1.6±0.20	R
AMK316ABJ107ML-T	AMK316 BJ107ML-T	4		X5R	100 μ	±20	10	150	1.6±0.20	R
AMK316BBJ157ML-T				X5R	150 μ	±20	10	150	1.6±0.30	R

【温度特性 BJ : B/X5R】厚度 0.85mm(D)

型号1	型号2	额定电压[V]	温度特性		静电容量 [F]	静电容量允许偏差 [%]	tan δ [%]	高温负载	厚度*3 [mm]	焊接方式 R:回流焊 W:波峰焊
								额定电压 x %		
UMK316 BJ105□D-T		50	B	X5R	1 μ	±10, ±20	3.5	150	0.85±0.10	R
UMK316 BJ225□D-T			B	X5R	2.2 μ	±10, ±20	3.5	150	0.85±0.10	R
UMK316ABJ475□D-T	UMK316 BJ475□D-T			X5R	4.7 μ	±10, ±20	10	150	0.85±0.10	R
TMK316 BJ105□D-T		25	B	X5R	1 μ	±10, ±20	3.5	200	0.85±0.10	R
TMK316 BJ225□D-T			B	X5R	2.2 μ	±10, ±20	3.5	150	0.85±0.10	R
TMK316 BJ475□D-T				X5R	4.7 μ	±10, ±20	5	150	0.85±0.10	R
TMK316ABJ106□D-T	TMK316 BJ106□D-TD			X5R	10 μ	±10, ±20	10	150	0.85±0.10	R
EMK316 BJ225□D-T		16	B	X5R	2.2 μ	±10, ±20	3.5	200	0.85±0.10	R
EMK316 BJ475□D-T			B	X5R	4.7 μ	±10, ±20	5	200	0.85±0.10	R
EMK316 BJ106□D-T				X5R	10 μ	±10, ±20	10	150	0.85±0.10	R
EMK316ABJ226MD-T	EMK316 BJ226MD-T			X5R	22 μ	±20	10	150	0.85±0.10	R
LMK316 BJ475□D-T		10	B	X5R	4.7 μ	±10, ±20	5	200	0.85±0.10	R
LMK316 BJ106□D-T			B	X5R	10 μ	±10, ±20	10	200	0.85±0.10	R
LMK316ABJ226MD-T	LMK316 BJ226MD-T			X5R	22 μ	±20	10	150	0.85±0.10	R
JMK316 BJ106□D-T		6.3	B	X5R	10 μ	±10, ±20	10	200	0.85±0.10	R
JMK316ABJ226MD-T	JMK316 BJ226MD-T			X5R	22 μ	±20	10	150	0.85±0.10	R
JMK316ABJ476MD-T	JMK316 BJ476MD-T			X5R	47 μ	±20	10	150	0.85±0.10	R

【温度特性 C7 : X7S】厚度 1.6mm(L)

型号1	型号2	额定电压[V]	温度特性		静电容量 [F]	静电容量允许偏差 [%]	tan δ [%]	高温负载	厚度*3 [mm]	焊接方式 R:回流焊 W:波峰焊
								额定电压 x %		
AMK316AC7476ML-T		4		X7S	47 μ	±20	10	150	1.6±0.20	R

【温度特性 C6 : X6S】厚度 1.6mm(L)

型号1	型号2	额定电压[V]	温度特性		静电容量 [F]	静电容量允许偏差 [%]	tan δ [%]	高温负载	厚度*3 [mm]	焊接方式 R:回流焊 W:波峰焊
								额定电压 x %		
EMK316BC6226ML-T		16		X6S	22 μ	±20	10	150	1.6±0.30	R
JMK316AC6476ML-T		6.3		X6S	47 μ	±20	10	150	1.6±0.20	R
AMK316AC6476ML-T		4		X6S	47 μ	±20	10	200	1.6±0.20	R
AMK316AC6107ML-T				X6S	100 μ	±20	10	150	1.6±0.20	R

【温度特性 B7 : X7R】厚度 1.6mm(L)

型号1	型号2	额定电压[V]	温度特性		静电容量 [F]	静电容量允许偏差 [%]	tan δ [%]	高温负载	厚度*3 [mm]	焊接方式 R:回流焊 W:波峰焊
								额定电压 x %		
UMK316 B7224□L-T		50		X7R	0.22 μ	±10, ±20	2.5	200	1.6±0.20	R/W
UMK316 B7474□L-T				X7R	0.47 μ	±10, ±20	3.5	200	1.6±0.20	R/W
UMK316 B7105□L-T				X7R	1 μ	±10, ±20	3.5	200	1.6±0.20	R
UMK316 B7225□L-T				X7R	2.2 μ	±10, ±20	10	150	1.6±0.20	R
UMK316AB7475□L-T	UMK316 B7475□L-T			X7R	4.7 μ	±10, ±20	10	150	1.6±0.20	R
TMK316 B7105□L-T		25		X7R	1 μ	±10, ±20	3.5	200	1.6±0.20	R/W
TMK316 B7225□L-T				X7R	2.2 μ	±10, ±20	3.5	200	1.6±0.20	R
TMK316AB7475□L-T	TMK316 B7475□L-T				X7R	4.7 μ	±10, ±20	10	200	1.6±0.20
TMK316AB7106□L-T	TMK316 B7106□L-TD			X7R	10 μ	±10, ±20	10	150	1.6±0.20	R
EMK316 B7225□L-T		16		X7R	2.2 μ	±10, ±20	3.5	200	1.6±0.20	R/W
EMK316AB7106□L-T	EMK316 B7106□L-TD				X7R	10 μ	±10, ±20	10	200	1.6±0.20
LMK316 B7225□L-T		10		X7R	2.2 μ	±10, ±20	3.5	200	1.6±0.20	R/W
LMK316 B7475□L-T				X7R	4.7 μ	±10, ±20	5	200	1.6±0.20	R
LMK316AB7106□L-T	LMK316 B7106□L-TD				X7R	10 μ	±10, ±20	10	200	1.6±0.20
LMK316AB7226□L-TR	LMK316 B7226□L-TD	6.3		X7R	22 μ	±10, ±20	10	150	1.6±0.20	R
JMK316 B7106□L-T				X7R	10 μ	±10, ±20	5	200	1.6±0.20	R

【温度特性 B7 : X7R】厚度 0.85mm(D)

型号1	型号2	额定电压[V]	温度特性		静电容量 [F]	静电容量允许偏差 [%]	tan δ [%]	高温负载	厚度*3 [mm]	焊接方式 R:回流焊 W:波峰焊
								额定电压 x %		
UMK316 B7225□D-T		50		X7R	2.2 μ	±10, ±20	10	150	0.85±0.10	R
TMK316AB7475□D-T		25		X7R	4.7 μ	±10, ±20	10	150	0.85±0.10	R
LMK316AB7106MD-T		10		X7R	10 μ	±20	10	150	0.85±0.10	R

【温度特性 F : F/Y5V】厚度 1.6mm(L)

型号1	型号2	额定电压[V]	温度特性		静电容量 [F]	静电容量允许偏差 [%]	tan δ [%]	高温负载	厚度*3 [mm]	焊接方式 R:回流焊 W:波峰焊
								额定电压 x %		
GMK316 F106ZL-T		35	F	Y5V	10 μ	+80/-20	9	200	1.6±0.20	R
TMK316 F106ZL-T		25	F	Y5V	10 μ	+80/-20	9	200	1.6±0.20	R
EMK316 F106ZL-T		16	F	Y5V	10 μ	+80/-20	9	200	1.6±0.20	R
LMK316 F226ZL-T		10	F	Y5V	22 μ	+80/-20	16	200	1.6±0.20	R

【温度特性 F : F/Y5V】厚度 1.25mm(G)

型号1	型号2	额定电压[V]	温度特性		静电容量 [F]	静电容量允许偏差 [%]	tan δ [%]	高温负载	厚度*3 [mm]	焊接方式 R:回流焊 W:波峰焊
								额定电压 x %		
UMK316 F225ZG-T		50	F	Y5V	2.2 μ	+80/-20	7	200	1.25±0.10	R/W
GMK316 F475ZG-T		35	F	Y5V	4.7 μ	+80/-20	7	200	1.25±0.10	R

▶ 本产品目录根据版面大小，仅记载了代表性产品规格，若考虑使用本公司产品时，请确认供货规格型号明细表中的详细规格。有关各商品的详细信息(特性图、可靠性信息、使用时的注意事项等)，请参阅本公司网站(<http://www.ty-top.com/>)。

■ 型号一览

【温度特性 F: F/Y5V】厚度 0.85mm(D)

型号1	型号2	额定电压 [V]	温度特性		静电容量 [F]	静电容量允许偏差 [%]	tan δ [%]	高温负载	厚度*3 [mm]	焊接方式 R:回流焊 W:波峰焊
								额定电压 x %		
LMK316 F475ZD-T		10	F	Y5V	4.7 μ	+80/-20	9	200	0.85±0.10	R
JMK316 F106ZD-T		6.3	F	Y5V	10 μ	+80/-20	16	200	0.85±0.10	R

● 325型

【温度特性 BJ: B/X5R】厚度 2.5mm(M)

型号1	型号2	额定电压 [V]	温度特性		静电容量 [F]	静电容量允许偏差 [%]	tan δ [%]	高温负载	厚度*3 [mm]	焊接方式 R:回流焊 W:波峰焊
								额定电压 x %		
UMK325 BJ475[M-T]		50		X5R	4.7 μ	±10, ±20	5	150	2.5±0.20	R
UMK325 BJ106[M-T]				X5R	10 μ	±10, ±20	5	150	2.5±0.20	R
GMK325 BJ226MM-T		35		X5R	22 μ	±20	10	150	2.5±0.20	R
TMK325 BJ106[M-T]				B	X5R*1	10 μ	±10, ±20	3.5	150	2.5±0.20
TMK325 BJ226[M-T]		25		X5R	22 μ	±10, ±20	5	150	2.5±0.20	R
TMK325ABJ476MM-T					X5R	47 μ	±20	10	150	2.5±0.30
EMK325 BJ226[M-T]		16		X5R	22 μ	±10, ±20	5	150	2.5±0.20	R
EMK325 BJ476MM-T				B	X5R	47 μ	±20	10	150	2.5±0.20
LMK325 BJ226[M-T]		10		X5R	22 μ	±10, ±20	5	200	2.5±0.20	R
LMK325 BJ476MM-T				B	X5R	47 μ	±20	10	150	2.5±0.20
LMK325ABJ107MM-T	LMK325 BJ107MM-T			X5R	100 μ	±20	10	150	2.5±0.30	R
JMK325 BJ476MM-T		6.3		X5R	47 μ	±20	10	150	2.5±0.20	R
JMK325ABJ107MM-T	JMK325 BJ107MM-T				X5R	100 μ	±20	10	150	2.5±0.30
JMK325ABJ227MM-T				X5R	220 μ	±20	10	150	2.5±0.30	R
AMK325ABJ227MM-T		4		X5R	220 μ	±20	10	150	2.5±0.30	R

【温度特性 BJ: B/X5R】厚度 1.9mm(Y,N)

型号1	型号2	额定电压 [V]	温度特性		静电容量 [F]	静电容量允许偏差 [%]	tan δ [%]	高温负载	厚度*3 [mm]	焊接方式 R:回流焊 W:波峰焊
								额定电压 x %		
UMK325 BJ475[N-T]		50		X5R	4.7 μ	±10, ±20	10	150	1.9±0.20	R
GMK325 BJ225MN-T				B	X5R	2.2 μ	±20	3.5	200	1.9±0.20
GMK325 BJ475[N-T]		35		X5R	4.7 μ	±10, ±20	10	150	1.9±0.20	R
GMK325 BJ106[N-T]				B	X5R	10 μ	±10, ±20	5	150	1.9±0.20
TMK325 BJ335MN-T		25		X5R*1	3.3 μ	±20	3.5	200	1.9±0.20	R
TMK325 BJ475[N-T]				B	X5R*1	4.7 μ	±10, ±20	3.5	200	1.9±0.20
TMK325 BJ106[N-T]				X5R	10 μ	±10, ±20	5	200	1.9±0.20	R
EMK325 BJ475[N-T]		16		X5R*1	4.7 μ	±10, ±20	3.5	200	1.9±0.20	R
EMK325 BJ106[N-T]				B	X5R	10 μ	±10, ±20	3.5	200	1.9±0.20
EMK325 BJ476MY-T				X5R	47 μ	±20	10	150	1.9±0.1/-0.2	R
LMK325 BJ226MY-T		10		X5R	22 μ	±20	5	150	1.9±0.1/-0.2	R
LMK325 BJ106[N-T]				B	X5R	10 μ	±10, ±20	3.5	200	1.9±0.20
JMK325 BJ226MY-T		6.3		X5R	22 μ	±20	5	200	1.9±0.1/-0.2	R
JMK325 BJ107MY-T				B	X5R	100 μ	±20	10	150	1.9±0.1/-0.2
JMK325 BJ476MN-T				X5R	47 μ	±20	10	150	1.9±0.20	R

【温度特性 BJ: B/X5R】厚度 0.85mm(D)

型号1	型号2	额定电压 [V]	温度特性		静电容量 [F]	静电容量允许偏差 [%]	tan δ [%]	高温负载	厚度*3 [mm]	焊接方式 R:回流焊 W:波峰焊
								额定电压 x %		
TMK325 BJ106[D-T]		25	B	X5R	10 μ	±10, ±20	5	150	0.85±0.10	R
EMK325 BJ106[D-T]				B	X5R	10 μ	±10, ±20	5	150	0.85±0.10
EMK325 BJ226MD-T		16	B	X5R	22 μ	±20	10	150	0.85±0.10	R
LMK325 BJ335[D-T]				B	X5R	3.3 μ	±10, ±20	3.5	200	0.85±0.10
LMK325 BJ475[D-T]		10	B	X5R	4.7 μ	±10, ±20	5	200	0.85±0.10	R
LMK325 BJ106[D-T]				B	X5R	10 μ	±10, ±20	5	150	0.85±0.10

【温度特性 C7: X7S】厚度 2.5mm(M)

型号1	型号2	额定电压 [V]	温度特性	静电容量 [F]	静电容量允许偏差 [%]	tan δ [%]	高温负载 额定电压 x %	厚度*3 [mm]	焊接方式 R:回流焊 W:波峰焊
JMK325AC7107MM-T		6.3	X7S	100 μ	±20	10	150	2.5±0.30	R

【温度特性 C6: X6S】厚度 2.5mm(M)

型号1	型号2	额定电压 [V]	温度特性	静电容量 [F]	静电容量允许偏差 [%]	tan δ [%]	高温负载 额定电压 x %	厚度*3 [mm]	焊接方式 R:回流焊 W:波峰焊
EMK325AC6476MM-T		16	X6S	47 μ	±20	10	150	2.5±0.30	R
JMK325AC6107MM-T		6.3	X6S	100 μ	±20	10	150	2.5±0.30	R

【温度特性 B7: X7R】厚度 2.5mm(M)

型号1	型号2	额定电压 [V]	温度特性	静电容量 [F]	静电容量允许偏差 [%]	tan δ [%]	高温负载 额定电压 x %	厚度*3 [mm]	焊接方式 R:回流焊 W:波峰焊	
UMK325 B7475[M-T]		50		X7R	4.7 μ	±10, ±20	5	150	2.5±0.20	R
UMK325AB7106[M-T]					X7R	10 μ	±10, ±20	10	150	2.5±0.30
TMK325AB7106[M-T]		25		X7R	10 μ	±10, ±20	10	150	2.5±0.30	R
TMK325 B7226[M-TR]					X7R	22 μ	±10, ±20	10	150	2.5±0.20
EMK325 B7226[M-TR]		16		X7R	22 μ	±10, ±20	10	150	2.5±0.20	R
LMK325 B7476[M-TR]		10		X7R	47 μ	±10, ±20	10	150	2.5±0.20	R
JMK325 B7476[M-TR]		6.3		X7R	47 μ	±10, ±20	10	200	2.5±0.20	R

▶ 本产品目录根据版面大小, 仅记载了代表性产品规格, 若考虑使用本公司产品时, 请确认供货规格型号明细表中的详细规格。
有关各商品的详细信息(特性图、可靠性信息、使用时的注意事项等), 请参阅本公司网站(<http://www.ty-top.com/>)。

■ 型号一览

【温度特性 B7: X7R】厚度 1.9mm(N)

型号1	型号2	额定电压[V]	温度特性		静电容量 [F]	静电容量允许偏差 [%]	tan δ [%]	高温负载	厚度*3 [mm]	焊接方式 R:回流焊 W:波峰焊
								额定电压 x %		
UMK325 B7475□N-TR		50		X7R	4.7 μ	±10, ±20	10	150	1.9±0.20	R
TMK325 B7335□N-T		25		X7R	3.3 μ	±10, ±20	3.5	200	1.9±0.20	R
TMK325 B7475□N-T				X7R	4.7 μ	±10, ±20	3.5	150	1.9±0.20	R
TMK325 B7106□N-TR				X7R	10 μ	±10, ±20	10	150	1.9±0.20	R
EMK325 B7475□N-T				X7R	4.7 μ	±10, ±20	3.5	200	1.9±0.20	R
EMK325 B7106□N-T		16		X7R	10 μ	±10, ±20	3.5	150	1.9±0.20	R
LMK325 B7106□N-T		10		X7R	10 μ	±10, ±20	3.5	200	1.9±0.20	R

【温度特性 F: F/Y5V】厚度 1.9mm(N)

型号1	型号2	额定电压[V]	温度特性		静电容量 [F]	静电容量允许偏差 [%]	tan δ [%]	高温负载	厚度*3 [mm]	焊接方式 R:回流焊 W:波峰焊
								额定电压 x %		
EMK325 F226ZN-T		16	F	Y5V	22 μ	+80/-20	16	200	1.9±0.20	R
LMK325 F226ZN-T		10	F	Y5V	22 μ	+80/-20	16	200	1.9±0.20	R
JMK325 F476ZN-T		6.3	F	Y5V	47 μ	+80/-20	16	200	1.9±0.20	R

多层陶瓷电容器 (温度补偿用)

● 042型

【温度特性 CG: CG/C0G】厚度 0.2mm(C,D)

型号1	型号2	额定电压[V]	温度特性		静电容量 [F]	静电容量允许偏差 [%]	Q值 (at 1MHz) (min)	高温负载	厚度*3 [mm]	焊接方式 R:回流焊 W:波峰焊
								额定电压 x %		
EMK042 CG0R4□D-W		16	CG	C0G	0.4 p	±0.1pF, ±0.25pF	408	200	0.2±0.02	R
EMK042 CG0R5□D-W			CG	C0G	0.5 p	±0.1pF, ±0.25pF	410	200	0.2±0.02	R
EMK042 CG0R6□D-W			CG	C0G	0.6 p	±0.1pF, ±0.25pF	412	200	0.2±0.02	R
EMK042 CG0R7□D-W			CG	C0G	0.7 p	±0.1pF, ±0.25pF	414	200	0.2±0.02	R
EMK042 CGR75□D-W			CG	C0G	0.75 p	±0.1pF, ±0.25pF	415	200	0.2±0.02	R
EMK042 CG0R8□D-W			CG	C0G	0.8 p	±0.1pF, ±0.25pF	416	200	0.2±0.02	R
EMK042 CG0R9□D-W			CG	C0G	0.9 p	±0.1pF, ±0.25pF	418	200	0.2±0.02	R
EMK042 CG010□D-W			CG	C0G	1 p	±0.1pF, ±0.25pF	420	200	0.2±0.02	R
EMK042 CG1R1□D-W			CG	C0G	1.1 p	±0.1pF, ±0.25pF	422	200	0.2±0.02	R
EMK042 CG1R2□D-W			CG	C0G	1.2 p	±0.1pF, ±0.25pF	424	200	0.2±0.02	R
EMK042 CG1R3□D-W			CG	C0G	1.3 p	±0.1pF, ±0.25pF	426	200	0.2±0.02	R
EMK042 CG1R4□D-W			CG	C0G	1.4 p	±0.1pF, ±0.25pF	428	200	0.2±0.02	R
EMK042 CG1R5□D-W			CG	C0G	1.5 p	±0.1pF, ±0.25pF	430	200	0.2±0.02	R
EMK042 CG1R6□D-W			CG	C0G	1.6 p	±0.1pF, ±0.25pF	432	200	0.2±0.02	R
EMK042 CG1R7□D-W			CG	C0G	1.7 p	±0.1pF, ±0.25pF	434	200	0.2±0.02	R
EMK042 CG1R8□D-W			CG	C0G	1.8 p	±0.1pF, ±0.25pF	436	200	0.2±0.02	R
EMK042 CG1R9□D-W			CG	C0G	1.9 p	±0.1pF, ±0.25pF	438	200	0.2±0.02	R
EMK042 CG020□D-W			CG	C0G	2 p	±0.1pF, ±0.25pF	440	200	0.2±0.02	R
EMK042 CG2R1□D-W			CG	C0G	2.1 p	±0.1pF, ±0.25pF	442	200	0.2±0.02	R
EMK042 CG2R2□D-W			CG	C0G	2.2 p	±0.1pF, ±0.25pF	444	200	0.2±0.02	R
EMK042 CG2R3□D-W			CG	C0G	2.3 p	±0.1pF, ±0.25pF	446	200	0.2±0.02	R
EMK042 CG2R4□D-W			CG	C0G	2.4 p	±0.1pF, ±0.25pF	448	200	0.2±0.02	R
EMK042 CG2R5□D-W			CG	C0G	2.5 p	±0.1pF, ±0.25pF	450	200	0.2±0.02	R
EMK042 CG2R6□D-W			CG	C0G	2.6 p	±0.1pF, ±0.25pF	452	200	0.2±0.02	R
EMK042 CG2R7□D-W			CG	C0G	2.7 p	±0.1pF, ±0.25pF	454	200	0.2±0.02	R
EMK042 CG2R8□D-W			CG	C0G	2.8 p	±0.1pF, ±0.25pF	456	200	0.2±0.02	R
EMK042 CG2R9□D-W			CG	C0G	2.9 p	±0.1pF, ±0.25pF	458	200	0.2±0.02	R
EMK042 CG030□D-W			CG	C0G	3 p	±0.1pF, ±0.25pF	460	200	0.2±0.02	R
EMK042 CG3R1□D-W			CG	C0G	3.1 p	±0.1pF, ±0.25pF	462	200	0.2±0.02	R
EMK042 CG3R2□D-W			CG	C0G	3.2 p	±0.1pF, ±0.25pF	464	200	0.2±0.02	R
EMK042 CG3R3□D-W			CG	C0G	3.3 p	±0.1pF, ±0.25pF	466	200	0.2±0.02	R
EMK042 CG3R4□D-W			CG	C0G	3.4 p	±0.1pF, ±0.25pF	468	200	0.2±0.02	R
EMK042 CG3R5□D-W			CG	C0G	3.5 p	±0.1pF, ±0.25pF	470	200	0.2±0.02	R
EMK042 CG3R6□D-W			CG	C0G	3.6 p	±0.1pF, ±0.25pF	472	200	0.2±0.02	R
EMK042 CG3R7□D-W			CG	C0G	3.7 p	±0.1pF, ±0.25pF	474	200	0.2±0.02	R
EMK042 CG3R8□D-W			CG	C0G	3.8 p	±0.1pF, ±0.25pF	476	200	0.2±0.02	R
EMK042 CG3R9□D-W			CG	C0G	3.9 p	±0.1pF, ±0.25pF	478	200	0.2±0.02	R
EMK042 CG040□D-W			CG	C0G	4 p	±0.1pF, ±0.25pF	480	200	0.2±0.02	R
EMK042 CG4R1□D-W			CG	C0G	4.1 p	±0.1pF, ±0.25pF	482	200	0.2±0.02	R
EMK042 CG4R2□D-W			CG	C0G	4.2 p	±0.1pF, ±0.25pF	484	200	0.2±0.02	R
EMK042 CG4R3□D-W			CG	C0G	4.3 p	±0.1pF, ±0.25pF	486	200	0.2±0.02	R
EMK042 CG4R4□D-W			CG	C0G	4.4 p	±0.1pF, ±0.25pF	488	200	0.2±0.02	R
EMK042 CG4R5□D-W			CG	C0G	4.5 p	±0.1pF, ±0.25pF	490	200	0.2±0.02	R
EMK042 CG4R6□D-W			CG	C0G	4.6 p	±0.1pF, ±0.25pF	492	200	0.2±0.02	R
EMK042 CG4R7□D-W			CG	C0G	4.7 p	±0.1pF, ±0.25pF	494	200	0.2±0.02	R
EMK042 CG4R8□D-W			CG	C0G	4.8 p	±0.1pF, ±0.25pF	496	200	0.2±0.02	R
EMK042 CG4R9□D-W			CG	C0G	4.9 p	±0.1pF, ±0.25pF	498	200	0.2±0.02	R
EMK042 CG050□D-W			CG	C0G	5 p	±0.1pF, ±0.25pF	500	200	0.2±0.02	R
EMK042 CG5R1DD-W			CG	C0G	5.1 p	±0.5pF	502	200	0.2±0.02	R
EMK042 CG5R2DD-W			CG	C0G	5.2 p	±0.5pF	504	200	0.2±0.02	R
EMK042 CG5R3DD-W			CG	C0G	5.3 p	±0.5pF	506	200	0.2±0.02	R
EMK042 CG5R4DD-W			CG	C0G	5.4 p	±0.5pF	508	200	0.2±0.02	R
EMK042 CG5R5DD-W			CG	C0G	5.5 p	±0.5pF	510	200	0.2±0.02	R
EMK042 CG5R6DD-W			CG	C0G	5.6 p	±0.5pF	512	200	0.2±0.02	R
EMK042 CG5R7DD-W			CG	C0G	5.7 p	±0.5pF	514	200	0.2±0.02	R
EMK042 CG5R8DD-W			CG	C0G	5.8 p	±0.5pF	516	200	0.2±0.02	R
EMK042 CG5R9DD-W			CG	C0G	5.9 p	±0.5pF	518	200	0.2±0.02	R
EMK042 CG060DD-W			CG	C0G	6 p	±0.5pF	520	200	0.2±0.02	R
EMK042 CG6R1DD-W			CG	C0G	6.1 p	±0.5pF	522	200	0.2±0.02	R
EMK042 CG6R2DD-W			CG	C0G	6.2 p	±0.5pF	524	200	0.2±0.02	R
EMK042 CG6R3DD-W		CG	C0G	6.3 p	±0.5pF	526	200	0.2±0.02	R	
EMK042 CG6R4DD-W		CG	C0G	6.4 p	±0.5pF	528	200	0.2±0.02	R	
EMK042 CG6R5DD-W		CG	C0G	6.5 p	±0.5pF	530	200	0.2±0.02	R	
EMK042 CG6R6DD-W		CG	C0G	6.6 p	±0.5pF	532	200	0.2±0.02	R	
EMK042 CG6R7DD-W		CG	C0G	6.7 p	±0.5pF	534	200	0.2±0.02	R	

▶ 本产品目录根据版面大小, 仅记载了代表性产品规格, 若考虑使用本公司产品时, 请确认供货规格型号明细表中的详细规格。有关各商品的详细信息(特性图、可靠性信息、使用时的注意事项等), 请参阅本公司网站(<http://www.ty-top.com/>)。

型号1	型号2	额定电压 [V]	温度特性		静电容量 [F]	静电容量允许偏差	Q值 (at 1MHz) (min)	高温负载	厚度*3 [mm]	焊接方式 R:回流焊 W:波峰焊
								额定电压 x %		
EMK042 CG6R8DD-W		16	CG	C0G	6.8 p	±0.5pF	536	200	0.2±0.02	R
EMK042 CG6R9DD-W			CG	C0G	6.9 p	±0.5pF	538	200	0.2±0.02	R
EMK042 CG70DD-W			CG	C0G	7 p	±0.5pF	540	200	0.2±0.02	R
EMK042 CG7R1DD-W			CG	C0G	7.1 p	±0.5pF	542	200	0.2±0.02	R
EMK042 CG7R2DD-W			CG	C0G	7.2 p	±0.5pF	544	200	0.2±0.02	R
EMK042 CG7R3DD-W			CG	C0G	7.3 p	±0.5pF	546	200	0.2±0.02	R
EMK042 CG7R4DD-W			CG	C0G	7.4 p	±0.5pF	548	200	0.2±0.02	R
EMK042 CG7R5DD-W			CG	C0G	7.5 p	±0.5pF	550	200	0.2±0.02	R
EMK042 CG7R6DD-W			CG	C0G	7.6 p	±0.5pF	552	200	0.2±0.02	R
EMK042 CG7R7DD-W			CG	C0G	7.7 p	±0.5pF	554	200	0.2±0.02	R
EMK042 CG7R8DD-W			CG	C0G	7.8 p	±0.5pF	556	200	0.2±0.02	R
EMK042 CG7R9DD-W			CG	C0G	7.9 p	±0.5pF	558	200	0.2±0.02	R
EMK042 CG80DD-W			CG	C0G	8 p	±0.5pF	560	200	0.2±0.02	R
EMK042 CG8R1DD-W			CG	C0G	8.1 p	±0.5pF	562	200	0.2±0.02	R
EMK042 CG8R2DD-W			CG	C0G	8.2 p	±0.5pF	564	200	0.2±0.02	R
EMK042 CG8R3DD-W			CG	C0G	8.3 p	±0.5pF	566	200	0.2±0.02	R
EMK042 CG8R4DD-W			CG	C0G	8.4 p	±0.5pF	568	200	0.2±0.02	R
EMK042 CG8R5DD-W			CG	C0G	8.5 p	±0.5pF	570	200	0.2±0.02	R
EMK042 CG8R6DD-W			CG	C0G	8.6 p	±0.5pF	572	200	0.2±0.02	R
EMK042 CG8R7DD-W			CG	C0G	8.7 p	±0.5pF	574	200	0.2±0.02	R
EMK042 CG8R8DD-W			CG	C0G	8.8 p	±0.5pF	576	200	0.2±0.02	R
EMK042 CG8R9DD-W			CG	C0G	8.9 p	±0.5pF	578	200	0.2±0.02	R
EMK042 CG90DD-W			CG	C0G	9 p	±0.5pF	580	200	0.2±0.02	R
EMK042 CG9R1DD-W			CG	C0G	9.1 p	±0.5pF	582	200	0.2±0.02	R
EMK042 CG9R2DD-W			CG	C0G	9.2 p	±0.5pF	584	200	0.2±0.02	R
EMK042 CG9R3DD-W			CG	C0G	9.3 p	±0.5pF	586	200	0.2±0.02	R
EMK042 CG9R4DD-W			CG	C0G	9.4 p	±0.5pF	588	200	0.2±0.02	R
EMK042 CG9R5DD-W			CG	C0G	9.5 p	±0.5pF	590	200	0.2±0.02	R
EMK042 CG9R6DD-W			CG	C0G	9.6 p	±0.5pF	592	200	0.2±0.02	R
EMK042 CG9R7DD-W			CG	C0G	9.7 p	±0.5pF	594	200	0.2±0.02	R
EMK042 CG9R8DD-W			CG	C0G	9.8 p	±0.5pF	596	200	0.2±0.02	R
EMK042 CG9R9DD-W			CG	C0G	9.9 p	±0.5pF	598	200	0.2±0.02	R
EMK042 CG100DD-W			CG	C0G	10 p	±0.5pF	600	200	0.2±0.02	R
EMK042 CG110JD-W			CG	C0G	11 p	±5%	620	200	0.2±0.02	R
EMK042 CG120JD-W			CG	C0G	12 p	±5%	640	200	0.2±0.02	R
EMK042 CG130JD-W			CG	C0G	13 p	±5%	660	200	0.2±0.02	R
EMK042 CG150JD-W			CG	C0G	15 p	±5%	700	200	0.2±0.02	R
EMK042 CG160JC-W			CG	C0G	16 p	±5%	720	200	0.2±0.02	R
EMK042 CG180JC-W			CG	C0G	18 p	±5%	760	200	0.2±0.02	R
EMK042 CG200JC-W			CG	C0G	20 p	±5%	800	200	0.2±0.02	R
EMK042 CG220JC-W			CG	C0G	22 p	±5%	840	200	0.2±0.02	R
EMK042 CG240JC-W			CG	C0G	24 p	±5%	880	200	0.2±0.02	R
EMK042 CG270JC-W			CG	C0G	27 p	±5%	940	200	0.2±0.02	R
EMK042 CG300JC-W			CG	C0G	30 p	±5%	1000	200	0.2±0.02	R
EMK042 CG330JC-W			CG	C0G	33 p	±5%	1000	200	0.2±0.02	R
EMK042 CG360JC-W			CG	C0G	36 p	±5%	1000	200	0.2±0.02	R
EMK042 CG390JC-W			CG	C0G	39 p	±5%	1000	200	0.2±0.02	R
EMK042 CG430JC-W			CG	C0G	43 p	±5%	1000	200	0.2±0.02	R
EMK042 CG470JC-W			CG	C0G	47 p	±5%	1000	200	0.2±0.02	R
EMK042 CG510JC-W			CG	C0G	51 p	±5%	1000	200	0.2±0.02	R
EMK042 CG560JC-W		CG	C0G	56 p	±5%	1000	200	0.2±0.02	R	
EMK042 CG620JC-W		CG	C0G	62 p	±5%	1000	200	0.2±0.02	R	
EMK042 CG680JC-W		CG	C0G	68 p	±5%	1000	200	0.2±0.02	R	
EMK042 CG750JC-W		CG	C0G	75 p	±5%	1000	200	0.2±0.02	R	
EMK042 CG820JC-W		CG	C0G	82 p	±5%	1000	200	0.2±0.02	R	
EMK042 CG910JC-W		CG	C0G	91 p	±5%	1000	200	0.2±0.02	R	
EMK042 CG101JC-W		CG	C0G	100 p	±5%	1000	200	0.2±0.02	R	

【温度特性 CΔ: CΔ/C0Δ】厚度 0.2mm(C,D)

型号1	型号2	额定电压 [V]	温度特性		静电容量 [F]	静电容量允许偏差	Q值 (at 1MHz) (min)	高温负载	厚度*3 [mm]	焊接方式 R:回流焊 W:波峰焊
								额定电压 x %		
EMK042 CK0R4□D-W		16	CK	C0K	0.4 p	±0.1pF, ±0.25pF	408	200	0.2±0.02	R
EMK042 CK0R5□D-W			CK	C0K	0.5 p	±0.1pF, ±0.25pF	410	200	0.2±0.02	R
EMK042 CK0R6□D-W			CK	C0K	0.6 p	±0.1pF, ±0.25pF	412	200	0.2±0.02	R
EMK042 CK0R7□D-W			CK	C0K	0.7 p	±0.1pF, ±0.25pF	414	200	0.2±0.02	R
EMK042 CKR75□D-W			CK	C0K	0.75 p	±0.1pF, ±0.25pF	415	200	0.2±0.02	R
EMK042 CK0R8□D-W			CK	C0K	0.8 p	±0.1pF, ±0.25pF	416	200	0.2±0.02	R
EMK042 CK0R9□D-W			CK	C0K	0.9 p	±0.1pF, ±0.25pF	418	200	0.2±0.02	R
EMK042 CK010□D-W			CK	C0K	1 p	±0.1pF, ±0.25pF	420	200	0.2±0.02	R
EMK042 CK1R1□D-W			CK	C0K	1.1 p	±0.1pF, ±0.25pF	422	200	0.2±0.02	R
EMK042 CK1R2□D-W			CK	C0K	1.2 p	±0.1pF, ±0.25pF	424	200	0.2±0.02	R
EMK042 CK1R3□D-W			CK	C0K	1.3 p	±0.1pF, ±0.25pF	426	200	0.2±0.02	R
EMK042 CK1R4□D-W			CK	C0K	1.4 p	±0.1pF, ±0.25pF	428	200	0.2±0.02	R
EMK042 CK1R5□D-W			CK	C0K	1.5 p	±0.1pF, ±0.25pF	430	200	0.2±0.02	R
EMK042 CK1R6□D-W			CK	C0K	1.6 p	±0.1pF, ±0.25pF	432	200	0.2±0.02	R
EMK042 CK1R7□D-W			CK	C0K	1.7 p	±0.1pF, ±0.25pF	434	200	0.2±0.02	R
EMK042 CK1R8□D-W			CK	C0K	1.8 p	±0.1pF, ±0.25pF	436	200	0.2±0.02	R
EMK042 CK1R9□D-W			CK	C0K	1.9 p	±0.1pF, ±0.25pF	438	200	0.2±0.02	R
EMK042 CK020□D-W			CK	C0K	2 p	±0.1pF, ±0.25pF	440	200	0.2±0.02	R
EMK042 CK2R1□D-W			CK	C0K	2.1 p	±0.1pF, ±0.25pF	442	200	0.2±0.02	R
EMK042 CK2R2□D-W			CK	C0K	2.2 p	±0.1pF, ±0.25pF	444	200	0.2±0.02	R
EMK042 CK2R3□D-W			CK	C0K	2.3 p	±0.1pF, ±0.25pF	446	200	0.2±0.02	R
EMK042 CK2R4□D-W			CK	C0K	2.4 p	±0.1pF, ±0.25pF	448	200	0.2±0.02	R
EMK042 CK2R5□D-W			CK	C0K	2.5 p	±0.1pF, ±0.25pF	450	200	0.2±0.02	R
EMK042 CK2R6□D-W			CK	C0K	2.6 p	±0.1pF, ±0.25pF	452	200	0.2±0.02	R
EMK042 CK2R7□D-W			CK	C0K	2.7 p	±0.1pF, ±0.25pF	454	200	0.2±0.02	R
EMK042 CK2R8□D-W			CK	C0K	2.8 p	±0.1pF, ±0.25pF	456	200	0.2±0.02	R
EMK042 CK2R9□D-W			CK	C0K	2.9 p	±0.1pF, ±0.25pF	458	200	0.2±0.02	R

▶ 本产品目录根据版面大小, 仅记载了代表性产品规格, 若考虑使用本公司产品时, 请确认供货规格型号明细表中的详细规格。
有关各商品的详细信息(特性图、可靠性信息、使用时的注意事项等), 请参阅本公司网站(<http://www.ty-top.com/>)。

型号1	型号2	额定电压[V]	温度特性		静电容量 [F]	静电容量允许偏差	Q值 (at 1MHz) (min)	高温负载	厚度*3 [mm]	焊接方式 R:回流焊 W:波峰焊
								额定电压 x %		
EMK042 CJ030[D-W]			CJ	C0J	3 p	±0.1pF, ±0.25pF	460	200	0.2±0.02	R
EMK042 CJ3R1[D-W]			CJ	C0J	3.1 p	±0.1pF, ±0.25pF	462	200	0.2±0.02	R
EMK042 CJ3R2[D-W]			CJ	C0J	3.2 p	±0.1pF, ±0.25pF	464	200	0.2±0.02	R
EMK042 CJ3R3[D-W]			CJ	C0J	3.3 p	±0.1pF, ±0.25pF	466	200	0.2±0.02	R
EMK042 CJ3R4[D-W]			CJ	C0J	3.4 p	±0.1pF, ±0.25pF	468	200	0.2±0.02	R
EMK042 CJ3R5[D-W]			CJ	C0J	3.5 p	±0.1pF, ±0.25pF	470	200	0.2±0.02	R
EMK042 CJ3R6[D-W]			CJ	C0J	3.6 p	±0.1pF, ±0.25pF	472	200	0.2±0.02	R
EMK042 CJ3R7[D-W]			CJ	C0J	3.7 p	±0.1pF, ±0.25pF	474	200	0.2±0.02	R
EMK042 CJ3R8[D-W]			CJ	C0J	3.8 p	±0.1pF, ±0.25pF	476	200	0.2±0.02	R
EMK042 CJ3R9[D-W]			CJ	C0J	3.9 p	±0.1pF, ±0.25pF	478	200	0.2±0.02	R
EMK042 CH040[D-W]			CH	C0H	4 p	±0.1pF, ±0.25pF	480	200	0.2±0.02	R
EMK042 CH4R1[D-W]			CH	C0H	4.1 p	±0.1pF, ±0.25pF	482	200	0.2±0.02	R
EMK042 CH4R2[D-W]			CH	C0H	4.2 p	±0.1pF, ±0.25pF	484	200	0.2±0.02	R
EMK042 CH4R3[D-W]			CH	C0H	4.3 p	±0.1pF, ±0.25pF	486	200	0.2±0.02	R
EMK042 CH4R4[D-W]			CH	C0H	4.4 p	±0.1pF, ±0.25pF	488	200	0.2±0.02	R
EMK042 CH4R5[D-W]			CH	C0H	4.5 p	±0.1pF, ±0.25pF	490	200	0.2±0.02	R
EMK042 CH4R6[D-W]			CH	C0H	4.6 p	±0.1pF, ±0.25pF	492	200	0.2±0.02	R
EMK042 CH4R7[D-W]			CH	C0H	4.7 p	±0.1pF, ±0.25pF	494	200	0.2±0.02	R
EMK042 CH4R8[D-W]			CH	C0H	4.8 p	±0.1pF, ±0.25pF	496	200	0.2±0.02	R
EMK042 CH4R9[D-W]			CH	C0H	4.9 p	±0.1pF, ±0.25pF	498	200	0.2±0.02	R
EMK042 CH050[D-W]			CH	C0H	5 p	±0.1pF, ±0.25pF	500	200	0.2±0.02	R
EMK042 CH5R1DD-W			CH	C0H	5.1 p	±0.5pF	502	200	0.2±0.02	R
EMK042 CH5R2DD-W			CH	C0H	5.2 p	±0.5pF	504	200	0.2±0.02	R
EMK042 CH5R3DD-W			CH	C0H	5.3 p	±0.5pF	506	200	0.2±0.02	R
EMK042 CH5R4DD-W			CH	C0H	5.4 p	±0.5pF	508	200	0.2±0.02	R
EMK042 CH5R5DD-W			CH	C0H	5.5 p	±0.5pF	510	200	0.2±0.02	R
EMK042 CH5R6DD-W			CH	C0H	5.6 p	±0.5pF	512	200	0.2±0.02	R
EMK042 CH5R7DD-W			CH	C0H	5.7 p	±0.5pF	514	200	0.2±0.02	R
EMK042 CH5R8DD-W			CH	C0H	5.8 p	±0.5pF	516	200	0.2±0.02	R
EMK042 CH5R9DD-W			CH	C0H	5.9 p	±0.5pF	518	200	0.2±0.02	R
EMK042 CH060DD-W			CH	C0H	6 p	±0.5pF	520	200	0.2±0.02	R
EMK042 CH6R1DD-W			CH	C0H	6.1 p	±0.5pF	522	200	0.2±0.02	R
EMK042 CH6R2DD-W			CH	C0H	6.2 p	±0.5pF	524	200	0.2±0.02	R
EMK042 CH6R3DD-W			CH	C0H	6.3 p	±0.5pF	526	200	0.2±0.02	R
EMK042 CH6R4DD-W			CH	C0H	6.4 p	±0.5pF	528	200	0.2±0.02	R
EMK042 CH6R5DD-W			CH	C0H	6.5 p	±0.5pF	530	200	0.2±0.02	R
EMK042 CH6R6DD-W			CH	C0H	6.6 p	±0.5pF	532	200	0.2±0.02	R
EMK042 CH6R7DD-W			CH	C0H	6.7 p	±0.5pF	534	200	0.2±0.02	R
EMK042 CH6R8DD-W			CH	C0H	6.8 p	±0.5pF	536	200	0.2±0.02	R
EMK042 CH6R9DD-W			CH	C0H	6.9 p	±0.5pF	538	200	0.2±0.02	R
EMK042 CH070DD-W			CH	C0H	7 p	±0.5pF	540	200	0.2±0.02	R
EMK042 CH7R1DD-W			CH	C0H	7.1 p	±0.5pF	542	200	0.2±0.02	R
EMK042 CH7R2DD-W			CH	C0H	7.2 p	±0.5pF	544	200	0.2±0.02	R
EMK042 CH7R3DD-W			CH	C0H	7.3 p	±0.5pF	546	200	0.2±0.02	R
EMK042 CH7R4DD-W			CH	C0H	7.4 p	±0.5pF	548	200	0.2±0.02	R
EMK042 CH7R5DD-W			CH	C0H	7.5 p	±0.5pF	550	200	0.2±0.02	R
EMK042 CH7R6DD-W			CH	C0H	7.6 p	±0.5pF	552	200	0.2±0.02	R
EMK042 CH7R7DD-W			CH	C0H	7.7 p	±0.5pF	554	200	0.2±0.02	R
EMK042 CH7R8DD-W			CH	C0H	7.8 p	±0.5pF	556	200	0.2±0.02	R
EMK042 CH7R9DD-W			CH	C0H	7.9 p	±0.5pF	558	200	0.2±0.02	R
EMK042 CH080DD-W			CH	C0H	8 p	±0.5pF	560	200	0.2±0.02	R
EMK042 CH8R1DD-W			CH	C0H	8.1 p	±0.5pF	562	200	0.2±0.02	R
EMK042 CH8R2DD-W			CH	C0H	8.2 p	±0.5pF	564	200	0.2±0.02	R
EMK042 CH8R3DD-W			CH	C0H	8.3 p	±0.5pF	566	200	0.2±0.02	R
EMK042 CH8R4DD-W			CH	C0H	8.4 p	±0.5pF	568	200	0.2±0.02	R
EMK042 CH8R5DD-W			CH	C0H	8.5 p	±0.5pF	570	200	0.2±0.02	R
EMK042 CH8R6DD-W			CH	C0H	8.6 p	±0.5pF	572	200	0.2±0.02	R
EMK042 CH8R7DD-W			CH	C0H	8.7 p	±0.5pF	574	200	0.2±0.02	R
EMK042 CH8R8DD-W			CH	C0H	8.8 p	±0.5pF	576	200	0.2±0.02	R
EMK042 CH8R9DD-W			CH	C0H	8.9 p	±0.5pF	578	200	0.2±0.02	R
EMK042 CH090DD-W			CH	C0H	9 p	±0.5pF	580	200	0.2±0.02	R
EMK042 CH9R1DD-W			CH	C0H	9.1 p	±0.5pF	582	200	0.2±0.02	R
EMK042 CH9R2DD-W			CH	C0H	9.2 p	±0.5pF	584	200	0.2±0.02	R
EMK042 CH9R3DD-W			CH	C0H	9.3 p	±0.5pF	586	200	0.2±0.02	R
EMK042 CH9R4DD-W			CH	C0H	9.4 p	±0.5pF	588	200	0.2±0.02	R
EMK042 CH9R5DD-W			CH	C0H	9.5 p	±0.5pF	590	200	0.2±0.02	R
EMK042 CH9R6DD-W			CH	C0H	9.6 p	±0.5pF	592	200	0.2±0.02	R
EMK042 CH9R7DD-W			CH	C0H	9.7 p	±0.5pF	594	200	0.2±0.02	R
EMK042 CH9R8DD-W			CH	C0H	9.8 p	±0.5pF	596	200	0.2±0.02	R
EMK042 CH9R9DD-W			CH	C0H	9.9 p	±0.5pF	598	200	0.2±0.02	R
EMK042 CH100DD-W			CH	C0H	10 p	±0.5pF	600	200	0.2±0.02	R
EMK042 CH110JD-W			CH	C0H	11 p	±5%	620	200	0.2±0.02	R
EMK042 CH120JD-W			CH	C0H	12 p	±5%	640	200	0.2±0.02	R
EMK042 CH130JD-W			CH	C0H	13 p	±5%	660	200	0.2±0.02	R
EMK042 CH150JD-W			CH	C0H	15 p	±5%	700	200	0.2±0.02	R
EMK042 CH160JC-W			CH	C0H	16 p	±5%	720	200	0.2±0.02	R
EMK042 CH180JC-W			CH	C0H	18 p	±5%	760	200	0.2±0.02	R
EMK042 CH200JC-W			CH	C0H	20 p	±5%	800	200	0.2±0.02	R
EMK042 CH220JC-W			CH	C0H	22 p	±5%	840	200	0.2±0.02	R
EMK042 CH240JC-W			CH	C0H	24 p	±5%	880	200	0.2±0.02	R
EMK042 CH270JC-W			CH	C0H	27 p	±5%	940	200	0.2±0.02	R
EMK042 CH300JC-W			CH	C0H	30 p	±5%	1000	200	0.2±0.02	R
EMK042 CH330JC-W			CH	C0H	33 p	±5%	1000	200	0.2±0.02	R
EMK042 CH360JC-W			CH	C0H	36 p	±5%	1000	200	0.2±0.02	R
EMK042 CH390JC-W			CH	C0H	39 p	±5%	1000	200	0.2±0.02	R
EMK042 CH430JC-W			CH	C0H	43 p	±5%	1000	200	0.2±0.02	R
EMK042 CH470JC-W			CH	C0H	47 p	±5%	1000	200	0.2±0.02	R
EMK042 CH510JC-W			CH	C0H	51 p	±5%	1000	200	0.2±0.02	R

16

▶ 本产品目录根据版面大小, 仅记载了代表性产品规格, 若考虑使用本公司产品时, 请确认供货规格型号明细表中的详细规格。有关各商品的详细信息(特性图、可靠性信息、使用时的注意事项等), 请参阅本公司网站(<http://www.ty-top.com/>)。

■ 型号一览

型号1	型号2	额定电压 [V]	温度特性		静电容量 [F]	静电容量允许偏差	Q值 (at 1MHz) (min)	高温负载	厚度*3 [mm]	焊接方式 R:回流焊 W:波峰焊
								额定电压 x %		
EMK042 CH560JC-W		16	CH	COH	56 p	±5%	1000	200	0.2±0.02	R
EMK042 CH620JC-W			CH	COH	62 p	±5%	1000	200	0.2±0.02	R
EMK042 CH680JC-W			CH	COH	68 p	±5%	1000	200	0.2±0.02	R
EMK042 CH750JC-W			CH	COH	75 p	±5%	1000	200	0.2±0.02	R
EMK042 CH820JC-W			CH	COH	82 p	±5%	1000	200	0.2±0.02	R
EMK042 CH910JC-W			CH	COH	91 p	±5%	1000	200	0.2±0.02	R
EMK042 CH101JC-W			CH	COH	100 p	±5%	1000	200	0.2±0.02	R

● 063型

【温度特性 CG: CG/C0G】厚度 0.3mm(T)

型号1	型号2	额定电压 [V]	温度特性		静电容量 [F]	静电容量允许偏差	Q值 (at 1MHz) (min)	高温负载	厚度*3 [mm]	焊接方式 R:回流焊 W:波峰焊
								额定电压 x %		
UMK063 CG0R2CT-F		50	CG	C0G	0.2 p	±0.25pF	404	200	0.3±0.03	R
UMK063 CG0R3CT-F			CG	C0G	0.3 p	±0.25pF	406	200	0.3±0.03	R
UMK063 CG0R4CT-F			CG	C0G	0.4 p	±0.25pF	408	200	0.3±0.03	R
UMK063 CG0R5CT-F			CG	C0G	0.5 p	±0.25pF	410	200	0.3±0.03	R
UMK063 CG0R6CT-F			CG	C0G	0.6 p	±0.25pF	412	200	0.3±0.03	R
UMK063 CG0R7CT-F			CG	C0G	0.7 p	±0.25pF	414	200	0.3±0.03	R
UMK063 CGR75CT-F			CG	C0G	0.75 p	±0.25pF	415	200	0.3±0.03	R
UMK063 CG0R8CT-F			CG	C0G	0.8 p	±0.25pF	416	200	0.3±0.03	R
UMK063 CG0R9CT-F			CG	C0G	0.9 p	±0.25pF	418	200	0.3±0.03	R
UMK063 CG010CT-F			CG	C0G	1 p	±0.25pF	420	200	0.3±0.03	R
UMK063 CG1R1CT-F			CG	C0G	1.1 p	±0.25pF	422	200	0.3±0.03	R
UMK063 CG1R2CT-F			CG	C0G	1.2 p	±0.25pF	424	200	0.3±0.03	R
UMK063 CG1R3CT-F			CG	C0G	1.3 p	±0.25pF	426	200	0.3±0.03	R
UMK063 CG1R4CT-F			CG	C0G	1.4 p	±0.25pF	428	200	0.3±0.03	R
UMK063 CG1R5CT-F			CG	C0G	1.5 p	±0.25pF	430	200	0.3±0.03	R
UMK063 CG1R6CT-F			CG	C0G	1.6 p	±0.25pF	432	200	0.3±0.03	R
UMK063 CG1R7CT-F			CG	C0G	1.7 p	±0.25pF	434	200	0.3±0.03	R
UMK063 CG1R8CT-F			CG	C0G	1.8 p	±0.25pF	436	200	0.3±0.03	R
UMK063 CG1R9CT-F			CG	C0G	1.9 p	±0.25pF	438	200	0.3±0.03	R
UMK063 CG020CT-F			CG	C0G	2 p	±0.25pF	440	200	0.3±0.03	R
UMK063 CG2R1CT-F			CG	C0G	2.1 p	±0.25pF	442	200	0.3±0.03	R
UMK063 CG2R2CT-F			CG	C0G	2.2 p	±0.25pF	444	200	0.3±0.03	R
UMK063 CG2R3CT-F			CG	C0G	2.3 p	±0.25pF	446	200	0.3±0.03	R
UMK063 CG2R4CT-F			CG	C0G	2.4 p	±0.25pF	448	200	0.3±0.03	R
UMK063 CG2R5CT-F			CG	C0G	2.5 p	±0.25pF	450	200	0.3±0.03	R
UMK063 CG2R6CT-F			CG	C0G	2.6 p	±0.25pF	452	200	0.3±0.03	R
UMK063 CG2R7CT-F			CG	C0G	2.7 p	±0.25pF	454	200	0.3±0.03	R
UMK063 CG2R8CT-F			CG	C0G	2.8 p	±0.25pF	456	200	0.3±0.03	R
UMK063 CG2R9CT-F			CG	C0G	2.9 p	±0.25pF	458	200	0.3±0.03	R
UMK063 CG030CT-F			CG	C0G	3 p	±0.25pF	460	200	0.3±0.03	R
UMK063 CG3R1CT-F			CG	C0G	3.1 p	±0.25pF	462	200	0.3±0.03	R
UMK063 CG3R2CT-F			CG	C0G	3.2 p	±0.25pF	464	200	0.3±0.03	R
UMK063 CG3R3CT-F			CG	C0G	3.3 p	±0.25pF	466	200	0.3±0.03	R
UMK063 CG3R4CT-F			CG	C0G	3.4 p	±0.25pF	468	200	0.3±0.03	R
UMK063 CG3R5CT-F			CG	C0G	3.5 p	±0.25pF	470	200	0.3±0.03	R
UMK063 CG3R6CT-F			CG	C0G	3.6 p	±0.25pF	472	200	0.3±0.03	R
UMK063 CG3R7CT-F			CG	C0G	3.7 p	±0.25pF	474	200	0.3±0.03	R
UMK063 CG3R8CT-F			CG	C0G	3.8 p	±0.25pF	476	200	0.3±0.03	R
UMK063 CG3R9CT-F			CG	C0G	3.9 p	±0.25pF	478	200	0.3±0.03	R
UMK063 CG040CT-F			CG	C0G	4 p	±0.25pF	480	200	0.3±0.03	R
UMK063 CG4R1CT-F			CG	C0G	4.1 p	±0.25pF	482	200	0.3±0.03	R
UMK063 CG4R2CT-F			CG	C0G	4.2 p	±0.25pF	484	200	0.3±0.03	R
UMK063 CG4R3CT-F			CG	C0G	4.3 p	±0.25pF	486	200	0.3±0.03	R
UMK063 CG4R4CT-F			CG	C0G	4.4 p	±0.25pF	488	200	0.3±0.03	R
UMK063 CG4R5CT-F			CG	C0G	4.5 p	±0.25pF	490	200	0.3±0.03	R
UMK063 CG4R6CT-F			CG	C0G	4.6 p	±0.25pF	492	200	0.3±0.03	R
UMK063 CG4R7CT-F			CG	C0G	4.7 p	±0.25pF	494	200	0.3±0.03	R
UMK063 CG4R8CT-F			CG	C0G	4.8 p	±0.25pF	496	200	0.3±0.03	R
UMK063 CG4R9CT-F		CG	C0G	4.9 p	±0.25pF	498	200	0.3±0.03	R	
UMK063 CG050CT-F		CG	C0G	5 p	±0.25pF	500	200	0.3±0.03	R	
UMK063 CG5R1DT-F		CG	C0G	5.1 p	±0.5pF	502	200	0.3±0.03	R	
UMK063 CG5R2DT-F		CG	C0G	5.2 p	±0.5pF	504	200	0.3±0.03	R	
UMK063 CG5R3DT-F		CG	C0G	5.3 p	±0.5pF	506	200	0.3±0.03	R	
UMK063 CG5R4DT-F		CG	C0G	5.4 p	±0.5pF	508	200	0.3±0.03	R	
UMK063 CG5R5DT-F		CG	C0G	5.5 p	±0.5pF	510	200	0.3±0.03	R	
UMK063 CG5R6DT-F		CG	C0G	5.6 p	±0.5pF	512	200	0.3±0.03	R	
UMK063 CG5R7DT-F		CG	C0G	5.7 p	±0.5pF	514	200	0.3±0.03	R	
UMK063 CG5R8DT-F		CG	C0G	5.8 p	±0.5pF	516	200	0.3±0.03	R	
UMK063 CG5R9DT-F		CG	C0G	5.9 p	±0.5pF	518	200	0.3±0.03	R	
UMK063 CG060DT-F		CG	C0G	6 p	±0.5pF	520	200	0.3±0.03	R	
UMK063 CG6R1DT-F		CG	C0G	6.1 p	±0.5pF	522	200	0.3±0.03	R	
UMK063 CG6R2DT-F		CG	C0G	6.2 p	±0.5pF	524	200	0.3±0.03	R	
UMK063 CG6R3DT-F		CG	C0G	6.3 p	±0.5pF	526	200	0.3±0.03	R	
UMK063 CG6R4DT-F		CG	C0G	6.4 p	±0.5pF	528	200	0.3±0.03	R	
UMK063 CG6R5DT-F		CG	C0G	6.5 p	±0.5pF	530	200	0.3±0.03	R	
UMK063 CG6R6DT-F		CG	C0G	6.6 p	±0.5pF	532	200	0.3±0.03	R	
UMK063 CG6R7DT-F		CG	C0G	6.7 p	±0.5pF	534	200	0.3±0.03	R	
UMK063 CG6R8DT-F		CG	C0G	6.8 p	±0.5pF	536	200	0.3±0.03	R	
UMK063 CG6R9DT-F		CG	C0G	6.9 p	±0.5pF	538	200	0.3±0.03	R	
UMK063 CG070DT-F		CG	C0G	7 p	±0.5pF	540	200	0.3±0.03	R	
UMK063 CG7R1DT-F		CG	C0G	7.1 p	±0.5pF	542	200	0.3±0.03	R	
UMK063 CG7R2DT-F		CG	C0G	7.2 p	±0.5pF	544	200	0.3±0.03	R	
UMK063 CG7R3DT-F		CG	C0G	7.3 p	±0.5pF	546	200	0.3±0.03	R	
UMK063 CG7R4DT-F		CG	C0G	7.4 p	±0.5pF	548	200	0.3±0.03	R	
UMK063 CG7R5DT-F		CG	C0G	7.5 p	±0.5pF	550	200	0.3±0.03	R	
UMK063 CG7R6DT-F		CG	C0G	7.6 p	±0.5pF	552	200	0.3±0.03	R	

▶ 本产品目录根据版面大小, 仅记载了代表性产品规格, 若考虑使用本公司产品时, 请确认供货规格型号明细表中的详细规格。有关各商品的详细信息(特性图、可靠性信息、使用时的注意事项等), 请参阅本公司网站(<http://www.ty-top.com/>)。

型号1	型号2	额定电压 [V]	温度特性		静电容量 [F]	静电容量允许偏差	Q值 (at 1MHz) (min)	高温负载	厚度*3 [mm]	焊接方式 R:回流焊 W:波峰焊
								额定电压 x %		
UMK063 CG7R7DT-F		50	CG	C0G	7.7 p	±0.5pF	554	200	0.3±0.03	R
UMK063 CG7R8DT-F			CG	C0G	7.8 p	±0.5pF	556	200	0.3±0.03	R
UMK063 CG7R9DT-F			CG	C0G	7.9 p	±0.5pF	558	200	0.3±0.03	R
UMK063 CG080DT-F			CG	C0G	8 p	±0.5pF	560	200	0.3±0.03	R
UMK063 CG8R1DT-F			CG	C0G	8.1 p	±0.5pF	562	200	0.3±0.03	R
UMK063 CG8R2DT-F			CG	C0G	8.2 p	±0.5pF	564	200	0.3±0.03	R
UMK063 CG8R3DT-F			CG	C0G	8.3 p	±0.5pF	566	200	0.3±0.03	R
UMK063 CG8R4DT-F			CG	C0G	8.4 p	±0.5pF	568	200	0.3±0.03	R
UMK063 CG8R5DT-F			CG	C0G	8.5 p	±0.5pF	570	200	0.3±0.03	R
UMK063 CG8R6DT-F			CG	C0G	8.6 p	±0.5pF	572	200	0.3±0.03	R
UMK063 CG8R7DT-F			CG	C0G	8.7 p	±0.5pF	574	200	0.3±0.03	R
UMK063 CG8R8DT-F			CG	C0G	8.8 p	±0.5pF	576	200	0.3±0.03	R
UMK063 CG8R9DT-F			CG	C0G	8.9 p	±0.5pF	578	200	0.3±0.03	R
UMK063 CG090DT-F			CG	C0G	9 p	±0.5pF	580	200	0.3±0.03	R
UMK063 CG9R1DT-F			CG	C0G	9.1 p	±0.5pF	582	200	0.3±0.03	R
UMK063 CG9R2DT-F			CG	C0G	9.2 p	±0.5pF	584	200	0.3±0.03	R
UMK063 CG9R3DT-F			CG	C0G	9.3 p	±0.5pF	586	200	0.3±0.03	R
UMK063 CG9R4DT-F			CG	C0G	9.4 p	±0.5pF	588	200	0.3±0.03	R
UMK063 CG9R5DT-F			CG	C0G	9.5 p	±0.5pF	590	200	0.3±0.03	R
UMK063 CG9R6DT-F			CG	C0G	9.6 p	±0.5pF	592	200	0.3±0.03	R
UMK063 CG9R7DT-F			CG	C0G	9.7 p	±0.5pF	594	200	0.3±0.03	R
UMK063 CG9R8DT-F			CG	C0G	9.8 p	±0.5pF	596	200	0.3±0.03	R
UMK063 CG9R9DT-F			CG	C0G	9.9 p	±0.5pF	598	200	0.3±0.03	R
UMK063 CG100DT-F			CG	C0G	10 p	±0.5pF	600	200	0.3±0.03	R
UMK063 CG110JT-F			CG	C0G	11 p	±5%	620	200	0.3±0.03	R
UMK063 CG120JT-F			CG	C0G	12 p	±5%	640	200	0.3±0.03	R
UMK063 CG130JT-F			CG	C0G	13 p	±5%	660	200	0.3±0.03	R
UMK063 CG150JT-F			CG	C0G	15 p	±5%	700	200	0.3±0.03	R
UMK063 CG160JT-F			CG	C0G	16 p	±5%	720	200	0.3±0.03	R
UMK063 CG180JT-F			CG	C0G	18 p	±5%	760	200	0.3±0.03	R
UMK063 CG200JT-F			CG	C0G	20 p	±5%	800	200	0.3±0.03	R
UMK063 CG220JT-F			CG	C0G	22 p	±5%	840	200	0.3±0.03	R
UMK063 CG240JT-F			CG	C0G	24 p	±5%	880	200	0.3±0.03	R
UMK063 CG270JT-F			CG	C0G	27 p	±5%	940	200	0.3±0.03	R
UMK063 CG300JT-F			CG	C0G	30 p	±5%	1000	200	0.3±0.03	R
UMK063 CG330JT-F			CG	C0G	33 p	±5%	1000	200	0.3±0.03	R
UMK063 CG360JT-F			CG	C0G	36 p	±5%	1000	200	0.3±0.03	R
UMK063 CG390JT-F			CG	C0G	39 p	±5%	1000	200	0.3±0.03	R
UMK063 CG430JT-F			CG	C0G	43 p	±5%	1000	200	0.3±0.03	R
UMK063 CG470JT-F			CG	C0G	47 p	±5%	1000	200	0.3±0.03	R
UMK063 CG510JT-F			CG	C0G	51 p	±5%	1000	200	0.3±0.03	R
UMK063 CG560JT-F			CG	C0G	56 p	±5%	1000	200	0.3±0.03	R
UMK063 CG620JT-F			CG	C0G	62 p	±5%	1000	200	0.3±0.03	R
UMK063 CG680JT-F			CG	C0G	68 p	±5%	1000	200	0.3±0.03	R
UMK063 CG750JT-F			CG	C0G	75 p	±5%	1000	200	0.3±0.03	R
UMK063 CG820JT-F			CG	C0G	82 p	±5%	1000	200	0.3±0.03	R
UMK063 CG910JT-F			CG	C0G	91 p	±5%	1000	200	0.3±0.03	R
UMK063 CG101JT-F			CG	C0G	100 p	±5%	1000	200	0.3±0.03	R
TMK063 CG111JT-F			CG	C0G	110 p	±5%	1000	200	0.3±0.03	R
TMK063 CG121JT-F			CG	C0G	120 p	±5%	1000	200	0.3±0.03	R
TMK063 CG131JT-F		CG	C0G	130 p	±5%	1000	200	0.3±0.03	R	
TMK063 CG151JT-F		CG	C0G	150 p	±5%	1000	200	0.3±0.03	R	
TMK063 CG181JT-F		CG	C0G	180 p	±5%	1000	200	0.3±0.03	R	
TMK063 CG201JT-F		CG	C0G	200 p	±5%	1000	200	0.3±0.03	R	
TMK063 CG221JT-F		CG	C0G	220 p	±5%	1000	200	0.3±0.03	R	

【温度特性 CΔ : CΔ/C0Δ】 厚度 0.3mm(T)

型号1	型号2	额定电压 [V]	温度特性		静电容量 [F]	静电容量允许偏差	Q值 (at 1MHz) (min)	高温负载	厚度*3 [mm]	焊接方式 R:回流焊 W:波峰焊
								额定电压 x %		
UMK063 CK0R2CT-F		50	CK	C0K	0.2 p	±0.25pF	404	200	0.3±0.03	R
UMK063 CK0R3CT-F			CK	C0K	0.3 p	±0.25pF	406	200	0.3±0.03	R
UMK063 CK0R4CT-F			CK	C0K	0.4 p	±0.25pF	408	200	0.3±0.03	R
UMK063 CK0R5CT-F			CK	C0K	0.5 p	±0.25pF	410	200	0.3±0.03	R
UMK063 CK0R6CT-F			CK	C0K	0.6 p	±0.25pF	412	200	0.3±0.03	R
UMK063 CK0R7CT-F			CK	C0K	0.7 p	±0.25pF	414	200	0.3±0.03	R
UMK063 CKR75CT-F			CK	C0K	0.75 p	±0.25pF	415	200	0.3±0.03	R
UMK063 CK0R8CT-F			CK	C0K	0.8 p	±0.25pF	416	200	0.3±0.03	R
UMK063 CK0R9CT-F			CK	C0K	0.9 p	±0.25pF	418	200	0.3±0.03	R
UMK063 CK010CT-F			CK	C0K	1 p	±0.25pF	420	200	0.3±0.03	R
UMK063 CK1R1CT-F			CK	C0K	1.1 p	±0.25pF	422	200	0.3±0.03	R
UMK063 CK1R2CT-F			CK	C0K	1.2 p	±0.25pF	424	200	0.3±0.03	R
UMK063 CK1R3CT-F			CK	C0K	1.3 p	±0.25pF	426	200	0.3±0.03	R
UMK063 CK1R4CT-F			CK	C0K	1.4 p	±0.25pF	428	200	0.3±0.03	R
UMK063 CK1R5CT-F			CK	C0K	1.5 p	±0.25pF	430	200	0.3±0.03	R
UMK063 CK1R6CT-F			CK	C0K	1.6 p	±0.25pF	432	200	0.3±0.03	R
UMK063 CK1R7CT-F			CK	C0K	1.7 p	±0.25pF	434	200	0.3±0.03	R
UMK063 CK1R8CT-F			CK	C0K	1.8 p	±0.25pF	436	200	0.3±0.03	R
UMK063 CK1R9CT-F			CK	C0K	1.9 p	±0.25pF	438	200	0.3±0.03	R
UMK063 CK020CT-F			CK	C0K	2 p	±0.25pF	440	200	0.3±0.03	R
UMK063 CK2R1CT-F			CK	C0K	2.1 p	±0.25pF	442	200	0.3±0.03	R
UMK063 CK2R2CT-F			CK	C0K	2.2 p	±0.25pF	444	200	0.3±0.03	R
UMK063 CK2R3CT-F			CK	C0K	2.3 p	±0.25pF	446	200	0.3±0.03	R
UMK063 CK2R4CT-F			CK	C0K	2.4 p	±0.25pF	448	200	0.3±0.03	R
UMK063 CK2R5CT-F			CK	C0K	2.5 p	±0.25pF	450	200	0.3±0.03	R
UMK063 CK2R6CT-F			CK	C0K	2.6 p	±0.25pF	452	200	0.3±0.03	R
UMK063 CK2R7CT-F			CK	C0K	2.7 p	±0.25pF	454	200	0.3±0.03	R
UMK063 CK2R8CT-F			CK	C0K	2.8 p	±0.25pF	456	200	0.3±0.03	R
UMK063 CK2R9CT-F			CK	C0K	2.9 p	±0.25pF	458	200	0.3±0.03	R

▶ 本产品目录根据版面大小, 仅记载了代表性产品规格, 若考虑使用本公司产品时, 请确认供货规格型号明细表中的详细规格。有关各商品的详细信息(特性图、可靠性信息、使用时的注意事项等), 请参阅本公司网站(<http://www.ty-top.com/>)。

型号1	型号2	额定电压 [V]	温度特性		静电容量 [F]	静电容量允许偏差	Q值 (at 1MHz) (min)	高温负载	厚度*3 [mm]	焊接方式 R:回流焊 W:波峰焊
								额定电压 x %		
UMK063 CJ030CT-F			CJ	C0J	3 p	±0.25pF	460	200	0.3±0.03	R
UMK063 CJ3R1CT-F			CJ	C0J	3.1 p	±0.25pF	462	200	0.3±0.03	R
UMK063 CJ3R2CT-F			CJ	C0J	3.2 p	±0.25pF	464	200	0.3±0.03	R
UMK063 CJ3R3CT-F			CJ	C0J	3.3 p	±0.25pF	466	200	0.3±0.03	R
UMK063 CJ3R4CT-F			CJ	C0J	3.4 p	±0.25pF	468	200	0.3±0.03	R
UMK063 CJ3R5CT-F			CJ	C0J	3.5 p	±0.25pF	470	200	0.3±0.03	R
UMK063 CJ3R6CT-F			CJ	C0J	3.6 p	±0.25pF	472	200	0.3±0.03	R
UMK063 CJ3R7CT-F			CJ	C0J	3.7 p	±0.25pF	474	200	0.3±0.03	R
UMK063 CJ3R8CT-F			CJ	C0J	3.8 p	±0.25pF	476	200	0.3±0.03	R
UMK063 CJ3R9CT-F			CJ	C0J	3.9 p	±0.25pF	478	200	0.3±0.03	R
UMK063 CH040CT-F			CH	COH	4 p	±0.25pF	480	200	0.3±0.03	R
UMK063 CH4R1CT-F			CH	COH	4.1 p	±0.25pF	482	200	0.3±0.03	R
UMK063 CH4R2CT-F			CH	COH	4.2 p	±0.25pF	484	200	0.3±0.03	R
UMK063 CH4R3CT-F			CH	COH	4.3 p	±0.25pF	486	200	0.3±0.03	R
UMK063 CH4R4CT-F			CH	COH	4.4 p	±0.25pF	488	200	0.3±0.03	R
UMK063 CH4R5CT-F			CH	COH	4.5 p	±0.25pF	490	200	0.3±0.03	R
UMK063 CH4R6CT-F			CH	COH	4.6 p	±0.25pF	492	200	0.3±0.03	R
UMK063 CH4R7CT-F			CH	COH	4.7 p	±0.25pF	494	200	0.3±0.03	R
UMK063 CH4R8CT-F			CH	COH	4.8 p	±0.25pF	496	200	0.3±0.03	R
UMK063 CH4R9CT-F			CH	COH	4.9 p	±0.25pF	498	200	0.3±0.03	R
UMK063 CH050CT-F			CH	COH	5 p	±0.25pF	500	200	0.3±0.03	R
UMK063 CH5R1DT-F			CH	COH	5.1 p	±0.5pF	502	200	0.3±0.03	R
UMK063 CH5R2DT-F			CH	COH	5.2 p	±0.5pF	504	200	0.3±0.03	R
UMK063 CH5R3DT-F			CH	COH	5.3 p	±0.5pF	506	200	0.3±0.03	R
UMK063 CH5R4DT-F			CH	COH	5.4 p	±0.5pF	508	200	0.3±0.03	R
UMK063 CH5R5DT-F			CH	COH	5.5 p	±0.5pF	510	200	0.3±0.03	R
UMK063 CH5R6DT-F			CH	COH	5.6 p	±0.5pF	512	200	0.3±0.03	R
UMK063 CH5R7DT-F			CH	COH	5.7 p	±0.5pF	514	200	0.3±0.03	R
UMK063 CH5R8DT-F			CH	COH	5.8 p	±0.5pF	516	200	0.3±0.03	R
UMK063 CH5R9DT-F			CH	COH	5.9 p	±0.5pF	518	200	0.3±0.03	R
UMK063 CH060DT-F			CH	COH	6 p	±0.5pF	520	200	0.3±0.03	R
UMK063 CH6R1DT-F			CH	COH	6.1 p	±0.5pF	522	200	0.3±0.03	R
UMK063 CH6R2DT-F			CH	COH	6.2 p	±0.5pF	524	200	0.3±0.03	R
UMK063 CH6R3DT-F			CH	COH	6.3 p	±0.5pF	526	200	0.3±0.03	R
UMK063 CH6R4DT-F			CH	COH	6.4 p	±0.5pF	528	200	0.3±0.03	R
UMK063 CH6R5DT-F			CH	COH	6.5 p	±0.5pF	530	200	0.3±0.03	R
UMK063 CH6R6DT-F			CH	COH	6.6 p	±0.5pF	532	200	0.3±0.03	R
UMK063 CH6R7DT-F			CH	COH	6.7 p	±0.5pF	534	200	0.3±0.03	R
UMK063 CH6R8DT-F			CH	COH	6.8 p	±0.5pF	536	200	0.3±0.03	R
UMK063 CH6R9DT-F			CH	COH	6.9 p	±0.5pF	538	200	0.3±0.03	R
UMK063 CH070DT-F			CH	COH	7 p	±0.5pF	540	200	0.3±0.03	R
UMK063 CH7R1DT-F			CH	COH	7.1 p	±0.5pF	542	200	0.3±0.03	R
UMK063 CH7R2DT-F			CH	COH	7.2 p	±0.5pF	544	200	0.3±0.03	R
UMK063 CH7R3DT-F			CH	COH	7.3 p	±0.5pF	546	200	0.3±0.03	R
UMK063 CH7R4DT-F			CH	COH	7.4 p	±0.5pF	548	200	0.3±0.03	R
UMK063 CH7R5DT-F			CH	COH	7.5 p	±0.5pF	550	200	0.3±0.03	R
UMK063 CH7R6DT-F			CH	COH	7.6 p	±0.5pF	552	200	0.3±0.03	R
UMK063 CH7R7DT-F			CH	COH	7.7 p	±0.5pF	554	200	0.3±0.03	R
UMK063 CH7R8DT-F			CH	COH	7.8 p	±0.5pF	556	200	0.3±0.03	R
UMK063 CH7R9DT-F			CH	COH	7.9 p	±0.5pF	558	200	0.3±0.03	R
UMK063 CH080DT-F			CH	COH	8 p	±0.5pF	560	200	0.3±0.03	R
UMK063 CH8R1DT-F			CH	COH	8.1 p	±0.5pF	562	200	0.3±0.03	R
UMK063 CH8R2DT-F			CH	COH	8.2 p	±0.5pF	564	200	0.3±0.03	R
UMK063 CH8R3DT-F			CH	COH	8.3 p	±0.5pF	566	200	0.3±0.03	R
UMK063 CH8R4DT-F			CH	COH	8.4 p	±0.5pF	568	200	0.3±0.03	R
UMK063 CH8R5DT-F			CH	COH	8.5 p	±0.5pF	570	200	0.3±0.03	R
UMK063 CH8R6DT-F			CH	COH	8.6 p	±0.5pF	572	200	0.3±0.03	R
UMK063 CH8R7DT-F			CH	COH	8.7 p	±0.5pF	574	200	0.3±0.03	R
UMK063 CH8R8DT-F			CH	COH	8.8 p	±0.5pF	576	200	0.3±0.03	R
UMK063 CH8R9DT-F			CH	COH	8.9 p	±0.5pF	578	200	0.3±0.03	R
UMK063 CH090DT-F			CH	COH	9 p	±0.5pF	580	200	0.3±0.03	R
UMK063 CH9R1DT-F			CH	COH	9.1 p	±0.5pF	582	200	0.3±0.03	R
UMK063 CH9R2DT-F			CH	COH	9.2 p	±0.5pF	584	200	0.3±0.03	R
UMK063 CH9R3DT-F			CH	COH	9.3 p	±0.5pF	586	200	0.3±0.03	R
UMK063 CH9R4DT-F			CH	COH	9.4 p	±0.5pF	588	200	0.3±0.03	R
UMK063 CH9R5DT-F			CH	COH	9.5 p	±0.5pF	590	200	0.3±0.03	R
UMK063 CH9R6DT-F			CH	COH	9.6 p	±0.5pF	592	200	0.3±0.03	R
UMK063 CH9R7DT-F			CH	COH	9.7 p	±0.5pF	594	200	0.3±0.03	R
UMK063 CH9R8DT-F			CH	COH	9.8 p	±0.5pF	596	200	0.3±0.03	R
UMK063 CH9R9DT-F			CH	COH	9.9 p	±0.5pF	598	200	0.3±0.03	R
UMK063 CH100DT-F			CH	COH	10 p	±0.5pF	600	200	0.3±0.03	R
UMK063 CH110JT-F			CH	COH	11 p	±5%	620	200	0.3±0.03	R
UMK063 CH120JT-F			CH	COH	12 p	±5%	640	200	0.3±0.03	R
UMK063 CH130JT-F			CH	COH	13 p	±5%	660	200	0.3±0.03	R
UMK063 CH150JT-F			CH	COH	15 p	±5%	700	200	0.3±0.03	R
UMK063 CH160JT-F			CH	COH	16 p	±5%	720	200	0.3±0.03	R
UMK063 CH180JT-F			CH	COH	18 p	±5%	760	200	0.3±0.03	R
UMK063 CH200JT-F			CH	COH	20 p	±5%	800	200	0.3±0.03	R
UMK063 CH220JT-F			CH	COH	22 p	±5%	840	200	0.3±0.03	R
UMK063 CH240JT-F			CH	COH	24 p	±5%	880	200	0.3±0.03	R
UMK063 CH270JT-F			CH	COH	27 p	±5%	940	200	0.3±0.03	R
UMK063 CH300JT-F			CH	COH	30 p	±5%	1000	200	0.3±0.03	R
UMK063 CH330JT-F			CH	COH	33 p	±5%	1000	200	0.3±0.03	R
UMK063 CH360JT-F			CH	COH	36 p	±5%	1000	200	0.3±0.03	R
UMK063 CH390JT-F			CH	COH	39 p	±5%	1000	200	0.3±0.03	R
UMK063 CH430JT-F			CH	COH	43 p	±5%	1000	200	0.3±0.03	R
UMK063 CH470JT-F			CH	COH	47 p	±5%	1000	200	0.3±0.03	R
UMK063 CH510JT-F			CH	COH	51 p	±5%	1000	200	0.3±0.03	R

50

▶ 本产品目录根据版面大小, 仅记载了代表性产品规格, 若考虑使用本公司产品时, 请确认供货规格型号明细表中的详细规格。有关各商品的详细信息(特性图、可靠性信息、使用时的注意事项等), 请参阅本公司网站(<http://www.ty-top.com/>)。

■ 型号一览

型号1	型号2	额定电压[V]	温度特性		静电容量 [F]	静电容量允许偏差	Q值 (at 1MHz) (min)	高温负载	厚度*3 [mm]	焊接方式 R:回流焊 W:波峰焊
								额定电压 x %		
UMK063 CH560JT-F		50	CH	C0H	56 p	±5%	1000	200	0.3±0.03	R
UMK063 CH620JT-F			CH	C0H	62 p	±5%	1000	200	0.3±0.03	R
UMK063 CH680JT-F			CH	C0H	68 p	±5%	1000	200	0.3±0.03	R
UMK063 CH750JT-F			CH	C0H	75 p	±5%	1000	200	0.3±0.03	R
UMK063 CH820JT-F			CH	C0H	82 p	±5%	1000	200	0.3±0.03	R
UMK063 CH910JT-F			CH	C0H	91 p	±5%	1000	200	0.3±0.03	R
UMK063 CH101JT-F			CH	C0H	100 p	±5%	1000	200	0.3±0.03	R
TMK063 CH111JT-F			CH	C0H	110 p	±5%	1000	200	0.3±0.03	R
TMK063 CH121JT-F			CH	C0H	120 p	±5%	1000	200	0.3±0.03	R
TMK063 CH131JT-F			CH	C0H	130 p	±5%	1000	200	0.3±0.03	R
TMK063 CH151JT-F		25	CH	C0H	150 p	±5%	1000	200	0.3±0.03	R
TMK063 CH181JT-F			CH	C0H	180 p	±5%	1000	200	0.3±0.03	R
TMK063 CH201JT-F			CH	C0H	200 p	±5%	1000	200	0.3±0.03	R
TMK063 CH221JT-F			CH	C0H	220 p	±5%	1000	200	0.3±0.03	R
			CH	C0H						

● 105型

【温度特性 CG : CG/C0G】 厚度 0.5mm(V)

型号1	型号2	额定电压[V]	温度特性		静电容量 [F]	静电容量允许偏差	Q值 (at 1MHz) (min)	高温负载	厚度*3 [mm]	焊接方式 R:回流焊 W:波峰焊
								额定电压 x %		
UMK105 CG0R5CV-F		50	CG	C0G	0.5 p	±0.25pF	410	200	0.5±0.05	R
UMK105 CG010CV-F			CG	C0G	1 p	±0.25pF	420	200	0.5±0.05	R
UMK105 CG1R5CV-F			CG	C0G	1.5 p	±0.25pF	430	200	0.5±0.05	R
UMK105 CG020CV-F			CG	C0G	2 p	±0.25pF	440	200	0.5±0.05	R
UMK105 CG030CV-F			CG	C0G	3 p	±0.25pF	460	200	0.5±0.05	R
UMK105 CG040CV-F			CG	C0G	4 p	±0.25pF	480	200	0.5±0.05	R
UMK105 CG050CV-F			CG	C0G	5 p	±0.25pF	500	200	0.5±0.05	R
UMK105 CG060DV-F			CG	C0G	6 p	±0.5pF	520	200	0.5±0.05	R
UMK105 CG070DV-F			CG	C0G	7 p	±0.5pF	540	200	0.5±0.05	R
UMK105 CG080DV-F			CG	C0G	8 p	±0.5pF	560	200	0.5±0.05	R
UMK105 CG090DV-F			CG	C0G	9 p	±0.5pF	580	200	0.5±0.05	R
UMK105 CG100DV-F			CG	C0G	10 p	±0.5pF	600	200	0.5±0.05	R
UMK105 CG120JV-F			CG	C0G	12 p	±5%	640	200	0.5±0.05	R
UMK105 CG150JV-F			CG	C0G	15 p	±5%	700	200	0.5±0.05	R
UMK105 CG180JV-F			CG	C0G	18 p	±5%	760	200	0.5±0.05	R
UMK105 CG220JV-F			CG	C0G	22 p	±5%	840	200	0.5±0.05	R
UMK105 CG270JV-F			CG	C0G	27 p	±5%	940	200	0.5±0.05	R
UMK105 CG330JV-F			CG	C0G	33 p	±5%	1000	200	0.5±0.05	R
UMK105 CG390JV-F			CG	C0G	39 p	±5%	1000	200	0.5±0.05	R
UMK105 CG470JV-F			CG	C0G	47 p	±5%	1000	200	0.5±0.05	R
UMK105 CG560JV-F			CG	C0G	56 p	±5%	1000	200	0.5±0.05	R
UMK105 CG680JV-F			CG	C0G	68 p	±5%	1000	200	0.5±0.05	R
UMK105 CG820JV-F			CG	C0G	82 p	±5%	1000	200	0.5±0.05	R
UMK105 CG101JV-F			CG	C0G	100 p	±5%	1000	200	0.5±0.05	R
UMK105 CG121JV-F			CG	C0G	120 p	±5%	1000	200	0.5±0.05	R
UMK105 CG151JV-F			CG	C0G	150 p	±5%	1000	200	0.5±0.05	R
UMK105 CG181JV-F			CG	C0G	180 p	±5%	1000	200	0.5±0.05	R
UMK105 CG221JV-F			CG	C0G	220 p	±5%	1000	200	0.5±0.05	R
UMK105 CG271JV-F			CG	C0G	270 p	±5%	1000	200	0.5±0.05	R
UMK105 CG331JV-F			CG	C0G	330 p	±5%	1000	200	0.5±0.05	R
UMK105 CG361JV-F			CG	C0G	360 p	±5%	1000	200	0.5±0.05	R
UMK105 CG391JV-F			CG	C0G	390 p	±5%	1000	200	0.5±0.05	R
UMK105 CG431JV-F			CG	C0G	430 p	±5%	1000	200	0.5±0.05	R
UMK105 CG471JV-F			CG	C0G	470 p	±5%	1000	200	0.5±0.05	R
UMK105 CG511JV-F			CG	C0G	510 p	±5%	1000	200	0.5±0.05	R
UMK105 CG561JV-F			CG	C0G	560 p	±5%	1000	200	0.5±0.05	R
UMK105 CG621JV-F			CG	C0G	620 p	±5%	1000	200	0.5±0.05	R
UMK105 CG681JV-F			CG	C0G	680 p	±5%	1000	200	0.5±0.05	R
UMK105 CG751JV-F			CG	C0G	750 p	±5%	1000	200	0.5±0.05	R
UMK105 CG821JV-F			CG	C0G	820 p	±5%	1000	200	0.5±0.05	R
UMK105 CG102JV-F		CG	C0G	1000 p	±5%	1000	200	0.5±0.05	R	

【温度特性 CΔ : CΔ/C0Δ】 厚度 0.5mm(V)

型号1	型号2	额定电压[V]	温度特性		静电容量 [F]	静电容量允许偏差	Q值 (at 1MHz) (min)	高温负载	厚度*3 [mm]	焊接方式 R:回流焊 W:波峰焊
								额定电压 x %		
UMK105 CK0R5CV-F		50	CK	C0K	0.5 p	±0.25pF	410	200	0.5±0.05	R
UMK105 CK010CV-F			CK	C0K	1 p	±0.25pF	420	200	0.5±0.05	R
UMK105 CK1R5CV-F			CK	C0K	1.5 p	±0.25pF	430	200	0.5±0.05	R
UMK105 CK020CV-F			CK	C0K	2 p	±0.25pF	440	200	0.5±0.05	R
UMK105 CJ030CV-F			CJ	C0J	3 p	±0.25pF	460	200	0.5±0.05	R
UMK105 CH040CV-F			CH	C0H	4 p	±0.25pF	480	200	0.5±0.05	R
UMK105 CH050CV-F			CH	C0H	5 p	±0.25pF	500	200	0.5±0.05	R
UMK105 CH060DV-F			CH	C0H	6 p	±0.5pF	520	200	0.5±0.05	R
UMK105 CH070DV-F			CH	C0H	7 p	±0.5pF	540	200	0.5±0.05	R
UMK105 CH080DV-F			CH	C0H	8 p	±0.5pF	560	200	0.5±0.05	R
UMK105 CH090DV-F			CH	C0H	9 p	±0.5pF	580	200	0.5±0.05	R
UMK105 CH100DV-F			CH	C0H	10 p	±0.5pF	600	200	0.5±0.05	R
UMK105 CH120JV-F			CH	C0H	12 p	±5%	640	200	0.5±0.05	R
UMK105 CH150JV-F			CH	C0H	15 p	±5%	700	200	0.5±0.05	R
UMK105 CH180JV-F			CH	C0H	18 p	±5%	760	200	0.5±0.05	R
UMK105 CH220JV-F			CH	C0H	22 p	±5%	840	200	0.5±0.05	R
UMK105 CH270JV-F			CH	C0H	27 p	±5%	940	200	0.5±0.05	R
UMK105 CH330JV-F			CH	C0H	33 p	±5%	1000	200	0.5±0.05	R
UMK105 CH390JV-F			CH	C0H	39 p	±5%	1000	200	0.5±0.05	R
UMK105 CH470JV-F			CH	C0H	47 p	±5%	1000	200	0.5±0.05	R
UMK105 CH560JV-F			CH	C0H	56 p	±5%	1000	200	0.5±0.05	R
UMK105 CH680JV-F			CH	C0H	68 p	±5%	1000	200	0.5±0.05	R
UMK105 CH820JV-F			CH	C0H	82 p	±5%	1000	200	0.5±0.05	R

▶ 本产品目录根据版面大小，仅记载了代表性产品规格，若考虑使用本公司产品时，请确认供货规格型号明细表中的详细规格。有关各商品的详细信息(特性图、可靠性信息、使用时的注意事项等)，请参阅本公司网站(<http://www.ty-top.com/>)。

型号1	型号2	额定电压 [V]	温度特性		静电容量 [F]	静电容量允许偏差	Q值 (at 1MHz) (min)	高温负载	厚度*3 [mm]	焊接方式 R:回流焊 W:波峰焊
								额定电压 x %		
UMK105 CH101JV-F		50	CH	C0H	100 p	±5%	1000	200	0.5±0.05	R
UMK105 CH121JV-F			CH	C0H	120 p	±5%	1000	200	0.5±0.05	R
UMK105 CH151JV-F			CH	C0H	150 p	±5%	1000	200	0.5±0.05	R
UMK105 CH181JV-F			CH	C0H	180 p	±5%	1000	200	0.5±0.05	R
UMK105 CH221JV-F			CH	C0H	220 p	±5%	1000	200	0.5±0.05	R
UMK105 CH271JV-F			CH	C0H	270 p	±5%	1000	200	0.5±0.05	R
UMK105 CH331JV-F			CH	C0H	330 p	±5%	1000	200	0.5±0.05	R
UMK105 CH361JV-F			CH	C0H	360 p	±5%	1000	200	0.5±0.05	R
UMK105 CH391JV-F			CH	C0H	390 p	±5%	1000	200	0.5±0.05	R
UMK105 CH431JV-F			CH	C0H	430 p	±5%	1000	200	0.5±0.05	R
UMK105 CH471JV-F			CH	C0H	470 p	±5%	1000	200	0.5±0.05	R
UMK105 CH511JV-F			CH	C0H	510 p	±5%	1000	200	0.5±0.05	R
UMK105 CH561JV-F			CH	C0H	560 p	±5%	1000	200	0.5±0.05	R
UMK105 CH621JV-F			CH	C0H	620 p	±5%	1000	200	0.5±0.05	R
UMK105 CH681JV-F			CH	C0H	680 p	±5%	1000	200	0.5±0.05	R
UMK105 CH751JV-F			CH	C0H	750 p	±5%	1000	200	0.5±0.05	R
UMK105 CH821JV-F			CH	C0H	820 p	±5%	1000	200	0.5±0.05	R
UMK105 CH102JV-F			CH	C0H	1000 p	±5%	1000	200	0.5±0.05	R

【温度特性 UΔ : UΔ/U2Δ】厚度 0.5mm(V)

型号1	型号2	额定电压 [V]	温度特性		静电容量 [F]	静电容量允许偏差	Q值 (at 1MHz) (min)	高温负载	厚度*3 [mm]	焊接方式 R:回流焊 W:波峰焊
								额定电压 x %		
UMK105 UK0R5CV-F		50	UK	U2K	0.5 p	±0.25pF	410	200	0.5±0.05	R
UMK105 UK010CV-F			UK	U2K	1 p	±0.25pF	420	200	0.5±0.05	R
UMK105 UK1R5CV-F			UK	U2K	1.5 p	±0.25pF	430	200	0.5±0.05	R
UMK105 UK020CV-F			UK	U2K	2 p	±0.25pF	440	200	0.5±0.05	R
UMK105 UK030CV-F			UK	U2K	3 p	±0.25pF	460	200	0.5±0.05	R
UMK105 UJ040CV-F			UJ	U2J	4 p	±0.25pF	480	200	0.5±0.05	R
UMK105 UJ050CV-F			UJ	U2J	5 p	±0.25pF	500	200	0.5±0.05	R
UMK105 UJ060DV-F			UJ	U2J	6 p	±0.5pF	520	200	0.5±0.05	R
UMK105 UJ070DV-F			UJ	U2J	7 p	±0.5pF	540	200	0.5±0.05	R
UMK105 UJ080DV-F			UJ	U2J	8 p	±0.5pF	560	200	0.5±0.05	R
UMK105 UJ090DV-F			UJ	U2J	9 p	±0.5pF	580	200	0.5±0.05	R
UMK105 UJ100DV-F			UJ	U2J	10 p	±0.5pF	600	200	0.5±0.05	R
UMK105 UJ120JV-F			UJ	U2J	12 p	±5%	640	200	0.5±0.05	R
UMK105 UJ150JV-F			UJ	U2J	15 p	±5%	700	200	0.5±0.05	R
UMK105 UJ180JV-F			UJ	U2J	18 p	±5%	760	200	0.5±0.05	R
UMK105 UJ220JV-F			UJ	U2J	22 p	±5%	840	200	0.5±0.05	R
UMK105 UJ270JV-F			UJ	U2J	27 p	±5%	940	200	0.5±0.05	R
UMK105 UJ330JV-F			UJ	U2J	33 p	±5%	1000	200	0.5±0.05	R
UMK105 UJ390JV-F			UJ	U2J	39 p	±5%	1000	200	0.5±0.05	R
UMK105 UJ470JV-F			UJ	U2J	47 p	±5%	1000	200	0.5±0.05	R
UMK105 UJ560JV-F			UJ	U2J	56 p	±5%	1000	200	0.5±0.05	R
UMK105 UJ680JV-F			UJ	U2J	68 p	±5%	1000	200	0.5±0.05	R
UMK105 UJ820JV-F			UJ	U2J	82 p	±5%	1000	200	0.5±0.05	R
UMK105 UJ101JV-F			UJ	U2J	100 p	±5%	1000	200	0.5±0.05	R
UMK105 UJ121JV-F			UJ	U2J	120 p	±5%	1000	200	0.5±0.05	R
UMK105 UJ151JV-F			UJ	U2J	150 p	±5%	1000	200	0.5±0.05	R
UMK105 UJ181JV-F			UJ	U2J	180 p	±5%	1000	200	0.5±0.05	R
UMK105 UJ221JV-F			UJ	U2J	220 p	±5%	1000	200	0.5±0.05	R
UMK105 UJ271JV-F			UJ	U2J	270 p	±5%	1000	200	0.5±0.05	R
UMK105 UJ331JV-F			UJ	U2J	330 p	±5%	1000	200	0.5±0.05	R

【温度特性 SL】厚度 0.5mm(V)

型号1	型号2	额定电压 [V]	温度特性		静电容量 [F]	静电容量允许偏差	Q值 (at 1MHz) (min)	高温负载	厚度*3 [mm]	焊接方式 R:回流焊 W:波峰焊
								额定电压 x %		
UMK105 SL121JV-F		50	SL		120 p	±5%	1000	200	0.5±0.05	R
UMK105 SL151JV-F			SL		150 p	±5%	1000	200	0.5±0.05	R
UMK105 SL181JV-F			SL		180 p	±5%	1000	200	0.5±0.05	R
UMK105 SL221JV-F			SL		220 p	±5%	1000	200	0.5±0.05	R
UMK105 SL271JV-F			SL		270 p	±5%	1000	200	0.5±0.05	R
UMK105 SL331JV-F			SL		330 p	±5%	1000	200	0.5±0.05	R

高频多层陶瓷电容器

●042型

【温度特性 CH : CH/C0H】厚度 0.2mm(C)

型号1	型号2	额定电压 [V]	温度特性		静电容量 [F]	静电容量允许偏差	Q值 (at 1GHz) (min)	高温负载	厚度*3 [mm]	焊接方式 R:回流焊 W:波峰焊
								额定电压 x %		
TVS042 CH0R2□C-W		25	CH	C0H	0.2 p	±0.1pF, 0.25pF	300	200	0.2±0.02	R
TVS042 CH0R3□C-W			CH	C0H	0.3 p	±0.1pF, 0.25pF	300	200	0.2±0.02	R
TVS042 CH0R4□C-W			CH	C0H	0.4 p	±0.1pF, 0.25pF	300	200	0.2±0.02	R
TVS042 CH0R5□C-W			CH	C0H	0.5 p	±0.1pF, 0.25pF	300	200	0.2±0.02	R
TVS042 CH0R6□C-W			CH	C0H	0.6 p	±0.1pF, 0.25pF	300	200	0.2±0.02	R
TVS042 CH0R7□C-W			CH	C0H	0.7 p	±0.1pF, 0.25pF	300	200	0.2±0.02	R
TVS042 CHR75□C-W			CH	C0H	0.75 p	±0.1pF, 0.25pF	300	200	0.2±0.02	R
TVS042 CH0R8□C-W			CH	C0H	0.8 p	±0.1pF, 0.25pF	300	200	0.2±0.02	R
TVS042 CH0R9□C-W			CH	C0H	0.9 p	±0.1pF, 0.25pF	300	200	0.2±0.02	R
TVS042 CH010□C-W			CH	C0H	1 p	±0.1pF, 0.25pF	300	200	0.2±0.02	R
TVS042 CH1R1□C-W			CH	C0H	1.1 p	±0.1pF, 0.25pF	280	200	0.2±0.02	R
TVS042 CH1R2□C-W			CH	C0H	1.2 p	±0.1pF, 0.25pF	270	200	0.2±0.02	R
TVS042 CH1R3□C-W			CH	C0H	1.3 p	±0.1pF, 0.25pF	260	200	0.2±0.02	R
TVS042 CH1R5□C-W			CH	C0H	1.5 p	±0.1pF, 0.25pF	240	200	0.2±0.02	R
TVS042 CH1R6□C-W			CH	C0H	1.6 p	±0.1pF, 0.25pF	230	200	0.2±0.02	R
TVS042 CH1R8□C-W			CH	C0H	1.8 p	±0.1pF, 0.25pF	210	200	0.2±0.02	R
TVS042 CH020□C-W			CH	C0H	2 p	±0.1pF, 0.25pF	190	200	0.2±0.02	R
TVS042 CH2R2□C-W			CH	C0H	2.2 p	±0.1pF, 0.25pF	180	200	0.2±0.02	R
TVS042 CH2R4□C-W			CH	C0H	2.4 p	±0.1pF, 0.25pF	170	200	0.2±0.02	R

▶ 本产品目录根据版面大小，仅记载了代表性产品规格，若考虑使用本公司产品时，请确认供货规格型号明细表中的详细规格。有关各商品的详细信息(特性图、可靠性信息、使用时的注意事项等)，请参阅本公司网站(<http://www.ty-top.com/>)。

■ 型号一览

型号1	型号2	额定电压[V]	温度特性		静电容量 [F]	静电容量允许偏差	Q值 (at 1GHz) (min)	高温负载	厚度*3 [mm]	焊接方式 R:回流焊 W:波峰焊
								额定电压 x %		
TVS042 CH2R7[C-W]		25	CH	C0H	2.7 p	±0.1pF, 0.25pF	150	200	0.2±0.02	R
TVS042 CH030[C-W]			CH	C0H	3 p	±0.1pF, 0.25pF	130	200	0.2±0.02	R
TVS042 CH3R3[C-W]			CH	C0H	3.3 p	±0.1pF, 0.25pF	120	200	0.2±0.02	R
TVS042 CH3R6[C-W]			CH	C0H	3.6 p	±0.1pF, 0.25pF	110	200	0.2±0.02	R
TVS042 CH3R9[C-W]			CH	C0H	3.9 p	±0.1pF, 0.25pF	100	200	0.2±0.02	R
TVS042 CH040[C-W]			CH	C0H	4 p	±0.1pF, 0.25pF	90	200	0.2±0.02	R
TVS042 CH4R3[C-W]			CH	C0H	4.3 p	±0.1pF, 0.25pF	85	200	0.2±0.02	R
TVS042 CH4R7[C-W]			CH	C0H	4.7 p	±0.1pF, 0.25pF	85	200	0.2±0.02	R
TVS042 CH050[C-W]			CH	C0H	5 p	±0.1pF, 0.25pF	80	200	0.2±0.02	R
TVS042 CH5R1[C-W]			CH	C0H	5.1 p	±0.25pF, 0.5pF	75	200	0.2±0.02	R
TVS042 CH5R6[C-W]			CH	C0H	5.6 p	±0.25pF, 0.5pF	70	200	0.2±0.02	R
TVS042 CH060[C-W]			CH	C0H	6 p	±0.25pF, 0.5pF	65	200	0.2±0.02	R
TVS042 CH6R2[C-W]			CH	C0H	6.2 p	±0.25pF, 0.5pF	65	200	0.2±0.02	R
TVS042 CH6R8[C-W]			CH	C0H	6.8 p	±0.25pF, 0.5pF	60	200	0.2±0.02	R
TVS042 CH070[C-W]			CH	C0H	7 p	±0.25pF, 0.5pF	60	200	0.2±0.02	R
TVS042 CH7R5[C-W]			CH	C0H	7.5 p	±0.25pF, 0.5pF	55	200	0.2±0.02	R
TVS042 CH080[C-W]			CH	C0H	8 p	±0.25pF, 0.5pF	55	200	0.2±0.02	R
TVS042 CH8R2[C-W]			CH	C0H	8.2 p	±0.25pF, 0.5pF	50	200	0.2±0.02	R
TVS042 CH090[C-W]			CH	C0H	9 p	±0.25pF, 0.5pF	50	200	0.2±0.02	R
TVS042 CH9R1[C-W]			CH	C0H	9.1 p	±0.25pF, 0.5pF	45	200	0.2±0.02	R
TVS042 CH100[C-W]			CH	C0H	10 p	±2%, ±5%	45	200	0.2±0.02	R
TVS042 CH110JC-W			CH	C0H	11 p	±5%	40	200	0.2±0.02	R
TVS042 CH120JC-W			CH	C0H	12 p	±5%	40	200	0.2±0.02	R
TVS042 CH130JC-W			CH	C0H	13 p	±5%	40	200	0.2±0.02	R
TVS042 CH150JC-W			CH	C0H	15 p	±5%	40	200	0.2±0.02	R
TVS042 CH160JC-W			CH	C0H	16 p	±5%	40	200	0.2±0.02	R
TVS042 CH180JC-W			CH	C0H	18 p	±5%	40	200	0.2±0.02	R
TVS042 CH220JC-W			CH	C0H	22 p	±5%	30	200	0.2±0.02	R

● 105型

【温度特性 CH : CH/C0H】厚度 0.5mm(W)

型号1	型号2	额定电压[V]	温度特性		静电容量 [F]	静电容量允许偏差	Q值 (at 1GHz) (min)	高温负载	厚度*3 [mm]	焊接方式 R:回流焊 W:波峰焊
								额定电压 x %		
EVK105 CH0R3BW-F		16	CH	C0H	0.3 p	±0.1pF	300	200	0.5±0.05	R
EVK105 CH0R4BW-F			CH	C0H	0.4 p	±0.1pF	300	200	0.5±0.05	R
EVK105 CH0R5BW-F			CH	C0H	0.5 p	±0.1pF	300	200	0.5±0.05	R
EVK105 CH0R6BW-F			CH	C0H	0.6 p	±0.1pF	300	200	0.5±0.05	R
EVK105 CH0R7BW-F			CH	C0H	0.7 p	±0.1pF	300	200	0.5±0.05	R
EVK105 CH0R8BW-F			CH	C0H	0.8 p	±0.1pF	300	200	0.5±0.05	R
EVK105 CH0R9BW-F			CH	C0H	0.9 p	±0.1pF	300	200	0.5±0.05	R
EVK105 CH010BW-F			CH	C0H	1 p	±0.1pF	300	200	0.5±0.05	R
EVK105 CH1R1BW-F			CH	C0H	1.1 p	±0.1pF	280	200	0.5±0.05	R
EVK105 CH1R2BW-F			CH	C0H	1.2 p	±0.1pF	270	200	0.5±0.05	R
EVK105 CH1R3BW-F			CH	C0H	1.3 p	±0.1pF	260	200	0.5±0.05	R
EVK105 CH1R5BW-F			CH	C0H	1.5 p	±0.1pF	240	200	0.5±0.05	R
EVK105 CH1R6BW-F			CH	C0H	1.6 p	±0.1pF	230	200	0.5±0.05	R
EVK105 CH1R8BW-F			CH	C0H	1.8 p	±0.1pF	210	200	0.5±0.05	R
EVK105 CH020BW-F			CH	C0H	2 p	±0.1pF	190	200	0.5±0.05	R
EVK105 CH2R2JW-F			CH	C0H	2.2 p	±5%	180	200	0.5±0.05	R
EVK105 CH2R4JW-F			CH	C0H	2.4 p	±5%	170	200	0.5±0.05	R
EVK105 CH2R7JW-F			CH	C0H	2.7 p	±5%	150	200	0.5±0.05	R
EVK105 CH030JW-F			CH	C0H	3 p	±5%	130	200	0.5±0.05	R
EVK105 CH3R3JW-F			CH	C0H	3.3 p	±5%	120	200	0.5±0.05	R
EVK105 CH3R6JW-F			CH	C0H	3.6 p	±5%	110	200	0.5±0.05	R
EVK105 CH3R9JW-F			CH	C0H	3.9 p	±5%	99	200	0.5±0.05	R
EVK105 CH4R3JW-F			CH	C0H	4.3 p	±5%	84	200	0.5±0.05	R
EVK105 CH4R7JW-F			CH	C0H	4.7 p	±5%	84	200	0.5±0.05	R
EVK105 CH5R1JW-F			CH	C0H	5.1 p	±5%	84	200	0.5±0.05	R

【温度特性 CH : CH/C0H】厚度 0.5mm(W)

型号1	型号2	额定电压[V]	温度特性		静电容量 [F]	静电容量允许偏差	Q值 (at 1GHz) (min)	高温负载	厚度*3 [mm]	焊接方式 R:回流焊 W:波峰焊
								额定电压 x %		
UVK105 CH0R3BW-F		50	CH	C0H	0.3 p	±0.1pF	300	200	0.5±0.05	R
UVK105 CH0R4BW-F			CH	C0H	0.4 p	±0.1pF	300	200	0.5±0.05	R
UVK105 CH0R5BW-F			CH	C0H	0.5 p	±0.1pF	300	200	0.5±0.05	R
UVK105 CH0R6BW-F			CH	C0H	0.6 p	±0.1pF	300	200	0.5±0.05	R
UVK105 CH0R7BW-F			CH	C0H	0.7 p	±0.1pF	300	200	0.5±0.05	R
UVK105 CH0R8BW-F			CH	C0H	0.8 p	±0.1pF	300	200	0.5±0.05	R
UVK105 CH0R9BW-F			CH	C0H	0.9 p	±0.1pF	300	200	0.5±0.05	R
UVK105 CH010BW-F			CH	C0H	1 p	±0.1pF	300	200	0.5±0.05	R
UVK105 CH1R1BW-F			CH	C0H	1.1 p	±0.1pF	280	200	0.5±0.05	R
UVK105 CH1R2BW-F			CH	C0H	1.2 p	±0.1pF	270	200	0.5±0.05	R
UVK105 CH1R3BW-F			CH	C0H	1.3 p	±0.1pF	260	200	0.5±0.05	R
UVK105 CH1R5BW-F			CH	C0H	1.5 p	±0.1pF	240	200	0.5±0.05	R
UVK105 CH1R6BW-F			CH	C0H	1.6 p	±0.1pF	230	200	0.5±0.05	R
UVK105 CH1R8BW-F			CH	C0H	1.8 p	±0.1pF	210	200	0.5±0.05	R
UVK105 CH020BW-F			CH	C0H	2 p	±0.1pF	190	200	0.5±0.05	R
UVK105 CH2R2JW-F			CH	C0H	2.2 p	±5%	180	200	0.5±0.05	R
UVK105 CH2R4JW-F			CH	C0H	2.4 p	±5%	170	200	0.5±0.05	R
UVK105 CH2R7JW-F			CH	C0H	2.7 p	±5%	150	200	0.5±0.05	R
UVK105 CH030JW-F			CH	C0H	3 p	±5%	130	200	0.5±0.05	R
UVK105 CH3R3JW-F			CH	C0H	3.3 p	±5%	120	200	0.5±0.05	R
UVK105 CH3R6JW-F			CH	C0H	3.6 p	±5%	110	200	0.5±0.05	R
UVK105 CH3R9JW-F			CH	C0H	3.9 p	±5%	99	200	0.5±0.05	R
UVK105 CH4R3JW-F			CH	C0H	4.3 p	±5%	84	200	0.5±0.05	R
UVK105 CH4R7JW-F			CH	C0H	4.7 p	±5%	84	200	0.5±0.05	R
UVK105 CH5R1JW-F			CH	C0H	5.1 p	±5%	84	200	0.5±0.05	R

▶ 本产品目录根据版面大小，仅记载了代表性产品规格，若考虑使用本公司产品时，请确认供货规格型号明细表中的详细规格。
有关各商品的详细信息(特性图、可靠性信息、使用时的注意事项等)，请参阅本公司网站(<http://www.ty-top.com/>)。

超低失真多层陶瓷电容器(CFCAP™)

● 105型

【温度特性 SD : Standard】厚度 0.5mm (V)

型号1	型号2	额定电压 [V]	温度特性	静电容量 [F]	静电容量允许偏差 [%]	tan δ [%]	高温负载	厚度*3 [mm]	焊接方式 R:回流焊 W:波峰焊
							额定电压 x %		
UMK105 SD391KV-F		50	Standard Type	390 p	±10	0.1	200	0.5±0.05	R
UMK105 SD471KV-F				470 p	±10	0.1	200	0.5±0.05	R
UMK105 SD561KV-F				560 p	±10	0.1	200	0.5±0.05	R
TMK105 SD681KV-F		25		680 p	±10	0.1	200	0.5±0.05	R
TMK105 SD821KV-F				820 p	±10	0.1	200	0.5±0.05	R
TMK105 SD102KV-F				1000 p	±10	0.1	200	0.5±0.05	R
TMK105 SD122KV-F		16		1200 p	±10	0.1	200	0.5±0.05	R
EMK105 SD152KV-F				1500 p	±10	0.1	200	0.5±0.05	R
EMK105 SD182KV-F				1800 p	±10	0.1	200	0.5±0.05	R
EMK105 SD222KV-F		10		2200 p	±10	0.1	200	0.5±0.05	R
EMK105 SD272KV-F				2700 p	±10	0.1	200	0.5±0.05	R
LMK105 SD332KV-F				3300 p	±10	0.1	200	0.5±0.05	R
LMK105 SD392KV-F		10		3900 p	±10	0.1	200	0.5±0.05	R
LMK105 SD472KV-F				4700 p	±10	0.1	200	0.5±0.05	R

【温度特性 SD : Standard】厚度 0.3mm (P)

型号1	型号2	额定电压 [V]	温度特性	静电容量 [F]	静电容量允许偏差 [%]	tan δ [%]	高温负载	厚度*3 [mm]	焊接方式 R:回流焊 W:波峰焊
							额定电压 x %		
LMK105 SD152KP-F		10	Standard Type	1500 p	±10	0.1	200	0.3±0.03	R
JMK105 SD272KP-F		6.3		2700 p	±10	0.1	200	0.3±0.03	R

● 107型

【温度特性 SD : Standard】厚度 0.8mm (A)

型号1	型号2	额定电压 [V]	温度特性	静电容量 [F]	静电容量允许偏差 [%]	tan δ [%]	高温负载	厚度*3 [mm]	焊接方式 R:回流焊 W:波峰焊	
							额定电压 x %			
UMK107 SD102KA-T		50	Standard Type	1000 p	±10	0.1	200	0.8±0.10	R	
UMK107 SD122KA-T				1200 p	±10	0.1	200	0.8±0.10	R	
UMK107 SD152KA-T				1500 p	±10	0.1	200	0.8±0.10	R	
UMK107 SD182KA-T				25	1800 p	±10	0.1	200	0.8±0.10	R
UMK107 SD222KA-T					2200 p	±10	0.1	200	0.8±0.10	R
UMK107 SD272KA-T					2700 p	±10	0.1	200	0.8±0.10	R
UMK107 SD332KA-T				16	3300 p	±10	0.1	200	0.8±0.10	R
TMK107 SD392KA-T					3900 p	±10	0.1	200	0.8±0.10	R
TMK107 SD472KA-T					4700 p	±10	0.1	200	0.8±0.10	R
EMK107 SD562KA-T		10		5600 p	±10	0.1	200	0.8±0.10	R	
EMK107 SD682KA-T				6800 p	±10	0.1	200	0.8±0.10	R	
EMK107 SD822KA-T				8200 p	±10	0.1	200	0.8±0.10	R	
EMK107 SD103KA-T		10		10000 p	±10	0.1	200	0.8±0.10	R	
LMK107 SD123KA-T				12000 p	±10	0.1	200	0.8±0.10	R	
LMK107 SD153KA-T				15000 p	±10	0.1	200	0.8±0.10	R	
LMK107 SD183KA-T				18000 p	±10	0.1	200	0.8±0.10	R	
LMK107 SD223KA-T				22000 p	±10	0.1	200	0.8±0.10	R	

● 212型

【温度特性 SD : Standard】厚度 1.25mm (G)

型号1	型号2	额定电压 [V]	温度特性	静电容量 [F]	静电容量允许偏差 [%]	tan δ [%]	高温负载	厚度*3 [mm]	焊接方式 R:回流焊 W:波峰焊
							额定电压 x %		
GMK212 SD183KG-T		35	Standard Type	18000 p	±10	0.1	200	1.25±0.10	R
GMK212 SD223KG-T				22000 p	±10	0.1	200	1.25±0.10	R
GMK212 SD273KG-T				27000 p	±10	0.1	200	1.25±0.10	R
LMK212 SD683KG-T		10		68000 p	±10	0.1	200	1.25±0.10	R
LMK212 SD823KG-T				82000 p	±10	0.1	200	1.25±0.10	R
LMK212 SD104KG-T				0.1 μ	±10	0.1	200	1.25±0.10	R

【温度特性 SD : Standard】厚度 0.85mm (D)

型号1	型号2	额定电压 [V]	温度特性	静电容量 [F]	静电容量允许偏差 [%]	tan δ [%]	高温负载	厚度*3 [mm]	焊接方式 R:回流焊 W:波峰焊	
							额定电压 x %			
UMK212 SD392KD-T		50	Standard Type	3900 p	±10	0.1	200	0.85±0.10	R	
UMK212 SD472KD-T				4700 p	±10	0.1	200	0.85±0.10	R	
UMK212 SD562KD-T				5600 p	±10	0.1	200	0.85±0.10	R	
UMK212 SD682KD-T				35	6800 p	±10	0.1	200	0.85±0.10	R
UMK212 SD822KD-T					8200 p	±10	0.1	200	0.85±0.10	R
UMK212 SD103KD-T					10000 p	±10	0.1	200	0.85±0.10	R
GMK212 SD123KD-T				16	12000 p	±10	0.1	200	0.85±0.10	R
GMK212 SD153KD-T					15000 p	±10	0.1	200	0.85±0.10	R
EMK212 SD333KD-T					33000 p	±10	0.1	200	0.85±0.10	R
LMK212 SD473KD-T		10		47000 p	±10	0.1	200	0.85±0.10	R	

● 316型

【温度特性 SD : Standard】厚度 1.6mm (L)

型号1	型号2	额定电压 [V]	温度特性	静电容量 [F]	静电容量允许偏差 [%]	tan δ [%]	高温负载	厚度*3 [mm]	焊接方式 R:回流焊 W:波峰焊
							额定电压 x %		
TMK316 SD823KL-T		25	Standard Type	82000 p	±10	0.1	200	1.6±0.20	R
TMK316 SD104KL-T				0.1 μ	±10	0.1	200	1.6±0.20	R

▶ 本产品目录根据版面大小, 仅记载了代表性产品规格, 若考虑使用本公司产品时, 请确认供货规格型号明细表中的详细规格。
有关各商品的详细信息(特性图、可靠性信息、使用时的注意事项等), 请参阅本公司网站(<http://www.ty-top.com/>)。

■ 型号一览

【温度特性 SD : Standard】厚度 1.15mm(F)

型号1	型号2	额定电压[V]	温度特性		静电容量 [F]	静电容量允许偏差 [%]	tan δ [%]	高温负载	厚度*3 [mm]	焊接方式 R:回流焊 W:波峰焊
								额定电压 x %		
GMK316 SD333KF-T		35	Standard Type		33000 p	±10	0.1	200	1.15±0.10	R
GMK316 SD393KF-T	39000 p				±10	0.1	200	1.15±0.10	R	
TMK316 SD473KF-T	47000 p	±10			0.1	200	1.15±0.10	R		
TMK316 SD563KF-T	56000 p	±10			0.1	200	1.15±0.10	R		
TMK316 SD683KF-T		25			68000 p	±10	0.1	200	1.15±0.10	R

低失真大容量多层陶瓷电容器(CF LD)

● 107型

【温度特性 LD : X5R】厚度 0.8mm(A)

型号1	型号2	额定电压[V]	温度特性		静电容量 [F]	静电容量允许偏差 [%]	tan δ [%]	高温负载	厚度*3 [mm]	焊接方式 R:回流焊 W:波峰焊
								额定电压 x %		
UMK107BLD224□A-T		50		X5R	0.22 μ	±10, ±20	10	150	0.8+0.20/-0	R
TMK107BLD474□A-T		25		X5R	0.47 μ	±10, ±20	10	150	0.8+0.20/-0	R
TMK107BLD105□A-T				X5R	1 μ	±10, ±20	10	150	0.8+0.20/-0	R

● 212型

【温度特性 LD : X5R】厚度 1.25mm(G)

型号1	型号2	额定电压[V]	温度特性		静电容量 [F]	静电容量允许偏差 [%]	tan δ [%]	高温负载	厚度*3 [mm]	焊接方式 R:回流焊 W:波峰焊
								额定电压 x %		
GMK212 LD105□G-T		35		X5R	1 μ	±10, ±20	10	150	1.25±0.10	R
GMK212BLD225□G-T				X5R	2.2 μ	±10, ±20	10	150	1.25+0.20/-0	R

● 316型

【温度特性 LD : X5R】厚度 1.6mm(L)

型号1	型号2	额定电压[V]	温度特性		静电容量 [F]	静电容量允许偏差 [%]	tan δ [%]	高温负载	厚度*3 [mm]	焊接方式 R:回流焊 W:波峰焊
								额定电压 x %		
UMK316 LD105□L-T		50		X5R	1 μ	±10, ±20	10	150	1.6±0.20	R
GMK316BLD475□L-T		35		X5R	4.7 μ	±10, ±20	10	150	1.6±0.30	R
TMK316BLD106□L-T		25		X5R	10 μ	±10, ±20	10	150	1.6±0.30	R

● 325型

【温度特性 LD : X5R】厚度 1.9mm(N)

型号1	型号2	额定电压[V]	温度特性		静电容量 [F]	静电容量允许偏差 [%]	tan δ [%]	高温负载	厚度*3 [mm]	焊接方式 R:回流焊 W:波峰焊
								额定电压 x %		
UMK325 LD105□N-T		50		X5R	1 μ	±10, ±20	10	200	1.9±0.20	R

【温度特性 LD : X5R】厚度 2.5mm(M)

型号1	型号2	额定电压[V]	温度特性		静电容量 [F]	静电容量允许偏差 [%]	tan δ [%]	高温负载	厚度*3 [mm]	焊接方式 R:回流焊 W:波峰焊
								额定电压 x %		
UMK325 LD155□M-T		50		X5R	1.5 μ	±10, ±20	5	150	2.5±0.20	R

中高耐压多层陶瓷电容器

● 107型

【温度特性 BJ : B/X5R】厚度 0.8mm(A)

型号1	型号2	额定电压[V]	温度特性		静电容量 [F]	静电容量允许偏差 [%]	tan δ [%]	高温负载	厚度*3 [mm]	焊接方式 R:回流焊 W:波峰焊
								额定电压 x %		
HMK107 BJ102□A-T		100	B	X5R*1	1000 p	±10, ±20	3.5	200	0.8±0.10	R
HMK107 BJ152□A-T			B	X5R*1	1500 p	±10, ±20	3.5	200	0.8±0.10	R
HMK107 BJ222□A-T			B	X5R*1	2200 p	±10, ±20	3.5	200	0.8±0.10	R
HMK107 BJ332□A-T			B	X5R*1	3300 p	±10, ±20	3.5	200	0.8±0.10	R
HMK107 BJ472□A-T			B	X5R*1	4700 p	±10, ±20	3.5	200	0.8±0.10	R
HMK107 BJ682□A-T			B	X5R*1	6800 p	±10, ±20	3.5	200	0.8±0.10	R
HMK107 BJ103□A-T			B	X5R*1	10000 p	±10, ±20	3.5	200	0.8±0.10	R
HMK107 BJ153□A-T			B	X5R*1	15000 p	±10, ±20	3.5	200	0.8±0.10	R
HMK107 BJ223□A-T			B	X5R*1	22000 p	±10, ±20	3.5	200	0.8±0.10	R
HMK107 BJ333□A-T			B	X5R*1	33000 p	±10, ±20	3.5	200	0.8±0.10	R
HMK107 BJ473□A-T			B	X5R*1	47000 p	±10, ±20	3.5	200	0.8±0.10	R
HMK107 BJ104□A-T			B	X5R*1	0.1 μ	±10, ±20	3.5	200	0.8±0.10	R

【温度特性 B7 : X7R, C7 : X7S】厚度 0.8mm(A)

型号1	型号2	额定电压[V]	温度特性		静电容量 [F]	静电容量允许偏差 [%]	tan δ [%]	高温负载	厚度*3 [mm]	焊接方式 R:回流焊 W:波峰焊	
								额定电压 x %			
HMK107 B7102□A-T		100		X7R	1000 p	±10, ±20	3.5	200	0.8±0.10	R	
HMK107 B7152□A-T				X7R	1500 p	±10, ±20	3.5	200	0.8±0.10	R	
HMK107 B7222□A-T				X7R	2200 p	±10, ±20	3.5	200	0.8±0.10	R	
HMK107 B7332□A-T				X7R	3300 p	±10, ±20	3.5	200	0.8±0.10	R	
HMK107 B7472□A-T				X7R	4700 p	±10, ±20	3.5	200	0.8±0.10	R	
HMK107 B7682□A-T				X7R	6800 p	±10, ±20	3.5	200	0.8±0.10	R	
HMK107 B7103□A-T				X7R	10000 p	±10, ±20	3.5	200	0.8±0.10	R	
HMK107 B7153□A-T				X7R	15000 p	±10, ±20	3.5	200	0.8±0.10	R	
HMK107 B7223□A-T				X7R	22000 p	±10, ±20	3.5	200	0.8±0.10	R	
HMK107 B7333□A-T				X7R	33000 p	±10, ±20	3.5	200	0.8±0.10	R	
HMK107 B7473□A-T				X7R	47000 p	±10, ±20	3.5	200	0.8±0.10	R	
HMK107 C7104□A-T					X7S	0.1 μ	±10, ±20	3.5	200	0.8±0.10	R

▶ 本产品目录根据版面大小, 仅记载了代表性产品规格, 若考虑使用本公司产品时, 请确认供货规格型号明细表中的详细规格。有关各商品的详细信息(特性图、可靠性信息、使用时的注意事项等), 请参阅本公司网站(<http://www.ty-top.com/>)。

■ 型号一览

● 212型

【温度特性 BJ : B/X5R】厚度 1.25mm(G)

型号1	型号2	额定电压 [V]	温度特性		静电容量 [F]	静电容量允许偏差 [%]	tan δ [%]	高温负载	厚度*3 [mm]	焊接方式 R:回流焊 W:波峰焊
								额定电压 x %		
HMK212 BJ103□G-T		100	B	X5R ⁺¹	10000 p	±10, ±20	3.5	200	1.25±0.10	R
HMK212 BJ153□G-T			B	X5R ⁺¹	15000 p	±10, ±20	3.5	200	1.25±0.10	R
HMK212 BJ223□G-T			B	X5R ⁺¹	22000 p	±10, ±20	3.5	200	1.25±0.10	R
HMK212 BJ333□G-T			B	X5R ⁺¹	33000 p	±10, ±20	3.5	200	1.25±0.10	R
HMK212 BJ473□G-T			B	X5R ⁺¹	47000 p	±10, ±20	3.5	200	1.25±0.10	R
HMK212 BJ683□G-T			B	X5R ⁺¹	68000 p	±10, ±20	3.5	200	1.25±0.10	R
HMK212 BJ104□G-T			B	X5R ⁺¹	0.1 μ	±10, ±20	3.5	200	1.25±0.10	R
HMK212 BJ224□G-T			B	X5R ⁺¹	0.22 μ	±10, ±20	3.5	200	1.25±0.10	R
QMK212 BJ472□G-T			B	X5R ⁺¹	4700 p	±10, ±20	2.5	150	1.25±0.10	R
QMK212 BJ682□G-T			B	X5R ⁺¹	6800 p	±10, ±20	2.5	150	1.25±0.10	R
QMK212 BJ103□G-T		250	B	X5R ⁺¹	10000 p	±10, ±20	2.5	150	1.25±0.10	R
QMK212 BJ153□G-T			B	X5R ⁺¹	15000 p	±10, ±20	2.5	150	1.25±0.10	R
QMK212 BJ223□G-T			B	X5R ⁺¹	22000 p	±10, ±20	2.5	150	1.25±0.10	R
QMK212 BJ332□G-T			B	X5R ⁺¹	3300 p	±10, ±20	2.5	150	1.25±0.10	R

【温度特性 BJ : B/X5R】厚度 0.85mm(D)

型号1	型号2	额定电压 [V]	温度特性		静电容量 [F]	静电容量允许偏差 [%]	tan δ [%]	高温负载	厚度*3 [mm]	焊接方式 R:回流焊 W:波峰焊
								额定电压 x %		
QMK212 BJ102□D-T		250	B	X5R ⁺¹	1000 p	±10, ±20	2.5	150	0.85±0.10	R
QMK212 BJ152□D-T			B	X5R ⁺¹	1500 p	±10, ±20	2.5	150	0.85±0.10	R
QMK212 BJ222□D-T			B	X5R ⁺¹	2200 p	±10, ±20	2.5	150	0.85±0.10	R
QMK212 BJ332□D-T			B	X5R ⁺¹	3300 p	±10, ±20	2.5	150	0.85±0.10	R

【温度特性 B7 : X7R】厚度 1.25mm(G)

型号1	型号2	额定电压 [V]	温度特性		静电容量 [F]	静电容量允许偏差 [%]	tan δ [%]	高温负载	厚度*3 [mm]	焊接方式 R:回流焊 W:波峰焊	
								额定电压 x %			
HMK212 B7103□G-T		100		X7R	10000 p	±10, ±20	3.5	200	1.25±0.10	R	
HMK212 B7153□G-T				X7R	15000 p	±10, ±20	3.5	200	1.25±0.10	R	
HMK212 B7223□G-T				X7R	22000 p	±10, ±20	3.5	200	1.25±0.10	R	
HMK212 B7333□G-T				X7R	33000 p	±10, ±20	3.5	200	1.25±0.10	R	
HMK212 B7473□G-T				X7R	47000 p	±10, ±20	3.5	200	1.25±0.10	R	
HMK212 B7683□G-T				X7R	68000 p	±10, ±20	3.5	200	1.25±0.10	R	
HMK212 B7104□G-T				X7R	0.1 μ	±10, ±20	3.5	200	1.25±0.10	R	
HMK212 B7224□G-T				X7R	0.22 μ	±10, ±20	3.5	200	1.25±0.10	R	
QMK212 B7472□G-T			250		X7R	4700 p	±10, ±20	2.5	150	1.25±0.10	R
QMK212 B7682□G-T					X7R	6800 p	±10, ±20	2.5	150	1.25±0.10	R
QMK212 B7103□G-T				X7R	10000 p	±10, ±20	2.5	150	1.25±0.10	R	
QMK212 B7153□G-T				X7R	15000 p	±10, ±20	2.5	150	1.25±0.10	R	
QMK212 B7223□G-T				X7R	22000 p	±10, ±20	2.5	150	1.25±0.10	R	

【温度特性 B7 : X7R】厚度 0.85mm(D)

型号1	型号2	额定电压 [V]	温度特性		静电容量 [F]	静电容量允许偏差 [%]	tan δ [%]	高温负载	厚度*3 [mm]	焊接方式 R:回流焊 W:波峰焊
								额定电压 x %		
QMK212 B7102□D-T		250		X7R	1000 p	±10, ±20	2.5	150	0.85±0.10	R
QMK212 B7152□D-T				X7R	1500 p	±10, ±20	2.5	150	0.85±0.10	R
QMK212 B7222□D-T				X7R	2200 p	±10, ±20	2.5	150	0.85±0.10	R
QMK212 B7332□D-T				X7R	3300 p	±10, ±20	2.5	150	0.85±0.10	R

● 316型

【温度特性 BJ : B/X5R】厚度 1.6mm(L)

型号1	型号2	额定电压 [V]	温度特性		静电容量 [F]	静电容量允许偏差 [%]	tan δ [%]	高温负载	厚度*3 [mm]	焊接方式 R:回流焊 W:波峰焊	
								额定电压 x %			
HMK316 BJ473□L-T		100	B	X5R ⁺¹	47000 p	±10, ±20	3.5	200	1.6±0.20	R	
HMK316 BJ683□L-T			B	X5R ⁺¹	68000 p	±10, ±20	3.5	200	1.6±0.20	R	
HMK316 BJ104□L-T			B	X5R ⁺¹	0.1 μ	±10, ±20	3.5	200	1.6±0.20	R	
HMK316 BJ154□L-T			B	X5R ⁺¹	0.15 μ	±10, ±20	3.5	200	1.6±0.20	R	
HMK316 BJ224□L-T			B	X5R ⁺¹	0.22 μ	±10, ±20	3.5	200	1.6±0.20	R	
HMK316 BJ334□L-T			B	X5R ⁺¹	0.33 μ	±10, ±20	3.5	200	1.6±0.20	R	
HMK316 BJ474□L-T			B	X5R ⁺¹	0.47 μ	±10, ±20	3.5	200	1.6±0.20	R	
HMK316 BJ105□L-T			B	X5R ⁺¹	1 μ	±10, ±20	3.5	200	1.6±0.20	R	
QMK316 BJ333□L-T			250	B	X5R ⁺¹	33000 p	±10, ±20	2.5	150	1.6±0.20	R
QMK316 BJ473□L-T				B	X5R ⁺¹	47000 p	±10, ±20	2.5	150	1.6±0.20	R
QMK316 BJ683□L-T		B		X5R ⁺¹	68000 p	±10, ±20	2.5	150	1.6±0.20	R	
QMK316 BJ104□L-T		B		X5R ⁺¹	0.1 μ	±10, ±20	2.5	150	1.6±0.20	R	
SMK316 BJ153□L-T		630	B	X5R ⁺¹	15000 p	±10, ±20	2.5	120	1.6±0.20	R	
SMK316 BJ223□L-T			B	X5R ⁺¹	22000 p	±10, ±20	2.5	120	1.6±0.20	R	

【温度特性 BJ : B/X5R】厚度 1.15mm(F)

型号1	型号2	额定电压 [V]	温度特性		静电容量 [F]	静电容量允许偏差 [%]	tan δ [%]	高温负载	厚度*3 [mm]	焊接方式 R:回流焊 W:波峰焊
								额定电压 x %		
SMK316 BJ102□F-T		630	B	X5R ⁺¹	1000 p	±10, ±20	2.5	120	1.15±0.10	R
SMK316 BJ152□F-T			B	X5R ⁺¹	1500 p	±10, ±20	2.5	120	1.15±0.10	R
SMK316 BJ222□F-T			B	X5R ⁺¹	2200 p	±10, ±20	2.5	120	1.15±0.10	R
SMK316 BJ332□F-T			B	X5R ⁺¹	3300 p	±10, ±20	2.5	120	1.15±0.10	R
SMK316 BJ472□F-T			B	X5R ⁺¹	4700 p	±10, ±20	2.5	120	1.15±0.10	R
SMK316 BJ682□F-T			B	X5R ⁺¹	6800 p	±10, ±20	2.5	120	1.15±0.10	R
SMK316 BJ103□F-T			B	X5R ⁺¹	10000 p	±10, ±20	2.5	120	1.15±0.10	R

▶ 本产品目录根据版面大小, 仅记载了代表性产品规格, 若考虑使用本公司产品时, 请确认供货规格型号明细表中的详细规格。
有关各商品的详细信息(特性图、可靠性信息、使用时的注意事项等), 请参阅本公司网站(<http://www.ty-top.com/>)。

■ 型号一览

【温度特性 B7 : X7R】厚度 1.6mm(L)

型号1	型号2	额定电压[V]	温度特性		静电容量 [F]	静电容量允许偏差 [%]	tan δ [%]	高温负载	厚度*3 [mm]	焊接方式 R:回流焊 W:波峰焊	
								额定电压 x %			
HMK316 B7473□L-T		100	X7R		47000 p	±10, ±20	3.5	200	1.6±0.20	R	
HMK316 B7683□L-T					68000 p	±10, ±20	3.5	200	1.6±0.20	R	
HMK316 B7104□L-T			X7R		0.1 μ	±10, ±20	3.5	200	1.6±0.20	R	
HMK316 B7154□L-T			X7R		0.15 μ	±10, ±20	3.5	200	1.6±0.20	R	
HMK316 B7224□L-T			X7R		0.22 μ	±10, ±20	3.5	200	1.6±0.20	R	
HMK316 B7334□L-T			X7R		0.33 μ	±10, ±20	3.5	200	1.6±0.20	R	
HMK316 B7474□L-T			X7R		0.47 μ	±10, ±20	3.5	200	1.6±0.20	R	
HMK316 B7105□L-T			X7R		1 μ	±10, ±20	3.5	200	1.6±0.20	R	
QMK316 B7333□L-T			250	X7R		33000 p	±10, ±20	2.5	150	1.6±0.20	R
QMK316 B7473□L-T				X7R		47000 p	±10, ±20	2.5	150	1.6±0.20	R
QMK316 B7683□L-T		X7R			68000 p	±10, ±20	2.5	150	1.6±0.20	R	
QMK316 B7104□L-T		X7R			0.1 μ	±10, ±20	2.5	150	1.6±0.20	R	
SMK316 B7153□L-T		630	X7R		15000 p	±10, ±20	2.5	120	1.6±0.20	R	
SMK316 B7223□L-T			X7R		22000 p	±10, ±20	2.5	120	1.6±0.20	R	

【温度特性 B7 : X7R】厚度 1.15mm(F)

型号1	型号2	额定电压[V]	温度特性		静电容量 [F]	静电容量允许偏差 [%]	tan δ [%]	高温负载	厚度*3 [mm]	焊接方式 R:回流焊 W:波峰焊
								额定电压 x %		
SMK316 B7102□F-T		630	X7R		1000 p	±10, ±20	2.5	120	1.15±0.10	R
SMK316 B7152□F-T					X7R		1500 p	±10, ±20	2.5	120
SMK316 B7222□F-T			X7R		2200 p	±10, ±20	2.5	120	1.15±0.10	R
SMK316 B7332□F-T			X7R		3300 p	±10, ±20	2.5	120	1.15±0.10	R
SMK316 B7472□F-T			X7R		4700 p	±10, ±20	2.5	120	1.15±0.10	R
SMK316 B7682□F-T			X7R		6800 p	±10, ±20	2.5	120	1.15±0.10	R
SMK316 B7103□F-T			X7R		10000 p	±10, ±20	2.5	120	1.15±0.10	R

● 325型

【温度特性 BJ : B/X5R】厚度 2.5mm(M)

型号1	型号2	额定电压[V]	温度特性		静电容量 [F]	静电容量允许偏差 [%]	tan δ [%]	高温负载	厚度*3 [mm]	焊接方式 R:回流焊 W:波峰焊
								额定电压 x %		
HMK325 BJ225□M-T		100	B	X5R ⁺	2.2 μ	±10, ±20	3.5	200	2.5±0.20	R

【温度特性 BJ : B/X5R】厚度 1.9mm(N)

型号1	型号2	额定电压[V]	温度特性		静电容量 [F]	静电容量允许偏差 [%]	tan δ [%]	高温负载	厚度*3 [mm]	焊接方式 R:回流焊 W:波峰焊	
								额定电压 x %			
HMK325 BJ154□N-T		100	B	X5R ⁺	0.15 μ	±10, ±20	3.5	200	1.9±0.20	R	
HMK325 BJ224□N-T					B	X5R ⁺	0.22 μ	±10, ±20	3.5	200	1.9±0.20
HMK325 BJ334□N-T			B	X5R ⁺	0.33 μ	±10, ±20	3.5	200	1.9±0.20	R	
HMK325 BJ474□N-T			B	X5R ⁺	0.47 μ	±10, ±20	3.5	200	1.9±0.20	R	
HMK325 BJ684□N-T			B	X5R ⁺	0.68 μ	±10, ±20	3.5	200	1.9±0.20	R	
HMK325 BJ105□N-T			B	X5R ⁺	1 μ	±10, ±20	3.5	200	1.9±0.20	R	
QMK325 BJ473□N-T			250	B	X5R ⁺	47000 p	±10, ±20	2.5	150	1.9±0.20	R
QMK325 BJ104□N-T				B	X5R ⁺	0.1 μ	±10, ±20	2.5	150	1.9±0.20	R
QMK325 BJ154□N-T				B	X5R ⁺	0.15 μ	±10, ±20	2.5	150	1.9±0.20	R
QMK325 BJ224□N-T				B	X5R ⁺	0.22 μ	±10, ±20	2.5	150	1.9±0.20	R
SMK325 BJ223□N-T		630	B	X5R ⁺	22000 p	±10, ±20	2.5	120	1.9±0.20	R	
SMK325 BJ333□N-T			B	X5R ⁺	33000 p	±10, ±20	2.5	120	1.9±0.20	R	
SMK325 BJ473□N-T			B	X5R ⁺	47000 p	±10, ±20	2.5	120	1.9±0.20	R	

【温度特性 BJ : B/X5R】厚度 1.15mm(F)

型号1	型号2	额定电压[V]	温度特性		静电容量 [F]	静电容量允许偏差 [%]	tan δ [%]	高温负载	厚度*3 [mm]	焊接方式 R:回流焊 W:波峰焊
								额定电压 x %		
HMK325 BJ104□F-T		100	B	X5R ⁺	0.1 μ	±10, ±20	3.5	200	1.15±0.10	R

【温度特性 B7 : X7R】厚度 2.5mm(M)

型号1	型号2	额定电压[V]	温度特性		静电容量 [F]	静电容量允许偏差 [%]	tan δ [%]	高温负载	厚度*3 [mm]	焊接方式 R:回流焊 W:波峰焊
								额定电压 x %		
HMK325 B7225□M-T		100		X7R	2.2 μ	±10, ±20	3.5	200	2.5±0.20	R

【温度特性 B7 : X7R】厚度 1.9mm(N)

型号1	型号2	额定电压[V]	温度特性		静电容量 [F]	静电容量允许偏差 [%]	tan δ [%]	高温负载	厚度*3 [mm]	焊接方式 R:回流焊 W:波峰焊	
								额定电压 x %			
HMK325 B7154□N-T		100	X7R		0.15 μ	±10, ±20	3.5	200	1.9±0.20	R	
HMK325 B7224□N-T					X7R		0.22 μ	±10, ±20	3.5	200	1.9±0.20
HMK325 B7334□N-T			X7R		0.33 μ	±10, ±20	3.5	200	1.9±0.20	R	
HMK325 B7474□N-T			X7R		0.47 μ	±10, ±20	3.5	200	1.9±0.20	R	
HMK325 B7684□N-T			X7R		0.68 μ	±10, ±20	3.5	200	1.9±0.20	R	
HMK325 B7105□N-T			X7R		1 μ	±10, ±20	3.5	200	1.9±0.20	R	
QMK325 B7473□N-T			250	X7R		47000 p	±10, ±20	2.5	150	1.9±0.20	R
QMK325 B7104□N-T				X7R		0.1 μ	±10, ±20	2.5	150	1.9±0.20	R
QMK325 B7154□N-T				X7R		0.15 μ	±10, ±20	2.5	150	1.9±0.20	R
QMK325 B7224□N-T				X7R		0.22 μ	±10, ±20	2.5	150	1.9±0.20	R
SMK325 B7223□N-T		630	X7R		22000 p	±10, ±20	2.5	120	1.9±0.20	R	
SMK325 B7333□N-T			X7R		33000 p	±10, ±20	2.5	120	1.9±0.20	R	
SMK325 B7473□N-T			X7R		47000 p	±10, ±20	2.5	120	1.9±0.20	R	

【温度特性 B7 : X7R】厚度 1.15mm(F)

型号1	型号2	额定电压[V]	温度特性		静电容量 [F]	静电容量允许偏差 [%]	tan δ [%]	高温负载	厚度*3 [mm]	焊接方式 R:回流焊 W:波峰焊
								额定电压 x %		
HMK325 B7104□F-T		100		X7R	0.1 μ	±10, ±20	3.5	200	1.15±0.10	R

▶ 本产品目录根据版面大小, 仅记载了代表性产品规格, 若考虑使用本公司产品时, 请确认供货规格型号明细表中的详细规格。
有关各商品的详细信息(特性图、可靠性信息、使用时的注意事项等), 请参阅本公司网站(<http://www.ty-top.com/>)。

■ 型号一览

● 432型

【温度特性 BJ: B/X5R】厚度 2.5mm(M)

型号1	型号2	额定电压 [V]	温度特性		静电容量 [F]	静电容量允许偏差 [%]	tan δ [%]	高温负载	厚度*3 [mm]	焊接方式 R:回流焊 W:波峰焊
								额定电压 x %		
HMK432 BJ474□M-T		100	B	X5R*1	0.47 μ	±10, ±20	3.5	200	2.5±0.20	R
HMK432 BJ105□M-T			B	X5R*1	1 μ	±10, ±20	3.5	200	2.5±0.20	R
HMK432 BJ155□M-T			B	X5R*1	1.5 μ	±10, ±20	3.5	200	2.5±0.20	R
HMK432 BJ225□M-T			B	X5R*1	2.2 μ	±10, ±20	3.5	200	2.5±0.20	R
QMK432 BJ104□M-T			B	X5R*1	0.1 μ	±10, ±20	2.5	150	2.5±0.20	R
QMK432 BJ224□M-T			B	X5R*1	0.22 μ	±10, ±20	2.5	150	2.5±0.20	R
QMK432 BJ334□M-T		250	B	X5R*1	0.33 μ	±10, ±20	2.5	150	2.5±0.20	R
QMK432 BJ474□M-T			B	X5R*1	0.47 μ	±10, ±20	2.5	150	2.5±0.20	R
SMK432 BJ473□M-T			B	X5R*1	47000 p	±10, ±20	2.5	120	2.5±0.20	R
SMK432 BJ683□M-T		630	B	X5R*1	68000 p	±10, ±20	2.5	120	2.5±0.20	R
SMK432 BJ104□M-T			B	X5R*1	0.1 μ	±10, ±20	2.5	120	2.5±0.20	R

【温度特性 B7: X7R】厚度 2.5mm(M)

型号1	型号2	额定电压 [V]	温度特性		静电容量 [F]	静电容量允许偏差 [%]	tan δ [%]	高温负载	厚度*3 [mm]	焊接方式 R:回流焊 W:波峰焊
								额定电压 x %		
HMK432 B7474□M-T		100		X7R	0.47 μ	±10, ±20	3.5	200	2.5±0.20	R
HMK432 B7105□M-T				X7R	1 μ	±10, ±20	3.5	200	2.5±0.20	R
HMK432 B7155□M-T				X7R	1.5 μ	±10, ±20	3.5	200	2.5±0.20	R
HMK432 B7225□M-T				X7R	2.2 μ	±10, ±20	3.5	200	2.5±0.20	R
QMK432 B7104□M-T				X7R	0.1 μ	±10, ±20	2.5	150	2.5±0.20	R
QMK432 B7224□M-T				X7R	0.22 μ	±10, ±20	2.5	150	2.5±0.20	R
QMK432 B7334□M-T		250		X7R	0.33 μ	±10, ±20	2.5	150	2.5±0.20	R
QMK432 B7474□M-T				X7R	0.47 μ	±10, ±20	2.5	150	2.5±0.20	R
SMK432 B7473□M-T				X7R	47000 p	±10, ±20	2.5	120	2.5±0.20	R
SMK432 B7683□M-T		630		X7R	68000 p	±10, ±20	2.5	120	2.5±0.20	R
SMK432 B7104□M-T				X7R	0.1 μ	±10, ±20	2.5	120	2.5±0.20	R

LW逆转型多层陶瓷电容器(LWDC™)

● 105型

【温度特性 BJ: X5R】厚度 0.3mm(P)

型号1	型号2	额定电压 [V]	温度特性		静电容量 [F]	静电容量允许偏差 [%]	tan δ [%]	高温负载	厚度*3 [mm]	焊接方式 R:回流焊 W:波峰焊	
								额定电压 x %			
TWK105 BJ104MP-F		25		X5R	0.1 μ	±20	5	150	0.3±0.05	R	
EWK105 BJ224MP-F		16		X5R	0.22 μ	±20	10	150	0.3±0.05	R	
LWK105 BJ474MP-F		10		X5R	0.47 μ	±20	10	150	0.3±0.05	R	
JWK105 BJ104MP-F		6.3		X5R*1	0.1 μ	±20	5	150	0.3±0.05	R	
JWK105 BJ474MP-F				X5R*1	0.47 μ	±20	10	150	0.3±0.05	R	
JWK105 BJ105MP-F				X5R	1 μ	±20	10	150	0.3±0.05	R	
JWK105 BJ225MP-F				X5R	2.2 μ	±20	10	150	0.3±0.05	R	
AWK105 BJ224MP-F			4		X5R	0.22 μ	±20	10	150	0.3±0.05	R

【温度特性 C6: X6S, C7: X7S】厚度 0.3mm(P)

型号1	型号2	额定电压 [V]	温度特性		静电容量 [F]	静电容量允许偏差 [%]	tan δ [%]	高温负载	厚度*3 [mm]	焊接方式 R:回流焊 W:波峰焊
								额定电压 x %		
EWK105 C6104MP-F		16		X6S	0.1 μ	±20	5	150	0.3±0.05	R
LWK105 C7104MP-F		10		X7S	0.1 μ	±20	5	150	0.3±0.05	R
LWK105 C6224MP-F				X6S	0.22 μ	±20	10	150	0.3±0.05	R
JWK105 C7104MP-F		6.3		X7S	0.1 μ	±20	5	150	0.3±0.05	R
JWK105 C7224MP-F				X7S	0.22 μ	±20	10	150	0.3±0.05	R
JWK105 C6474MP-F				X6S	0.47 μ	±20	10	150	0.3±0.05	R
AWK105 C6224MP-F		4		X6S	0.22 μ	±20	10	150	0.3±0.05	R
AWK105 C6474MP-F				X6S	0.47 μ	±20	10	150	0.3±0.05	R
AWK105 C6105MP-F				X6S	1 μ	±20	10	150	0.3±0.05	R
AWK105 C6225MP-F				X6S	2.2 μ	±20	10	150	0.3±0.05	R

● 107型

【温度特性 BJ: B/X5R】厚度 0.5mm(V)

型号1	型号2	额定电压 [V]	温度特性		静电容量 [F]	静电容量允许偏差 [%]	tan δ [%]	高温负载	厚度*3 [mm]	焊接方式 R:回流焊 W:波峰焊
								额定电压 x %		
TWK107 BJ104MV-T		25		X5R*1	0.1 μ	±20	5	150	0.5±0.05	R
EWK107 BJ224MV-T		16		X5R*1	0.22 μ	±20	5	150	0.5±0.05	R
EWK107 BJ474MV-T				X5R*1	0.47 μ	±20	5	150	0.5±0.05	R
LWK107 BJ105MV-T		10		X5R	1 μ	±20	10	150	0.5±0.05	R
LWK107 BJ225MV-T				X5R	2.2 μ	±20	10	150	0.5±0.05	R
JWK107 BJ105MV-T				X5R*1	1 μ	±20	10	150	0.5±0.05	R
JWK107 BJ225MV-T		6.3		X5R	2.2 μ	±20	10	150	0.5±0.05	R
JWK107 BJ475MV-T				X5R	4.7 μ	±20	10	150	0.5±0.05	R
AWK107 BJ106MV-T		4		X5R	10 μ	±20	10	150	0.5±0.05	R

【温度特性 B7: X7R, C6: X6S, C7: X7S】厚度 0.5mm(V)

型号1	型号2	额定电压 [V]	温度特性		静电容量 [F]	静电容量允许偏差 [%]	tan δ [%]	高温负载	厚度*3 [mm]	焊接方式 R:回流焊 W:波峰焊
								额定电压 x %		
TWK107 B7104MV-T		25		X7R	0.1 μ	±20	5	150	0.5±0.05	R
EWK107 B7224MV-T		16		X7R	0.22 μ	±20	5	150	0.5±0.05	R
EWK107 B7474MV-T				X7R	0.47 μ	±20	5	150	0.5±0.05	R
JWK107 C7105MV-T		6.3		X7S	1 μ	±20	10	150	0.5±0.05	R
AWK107 C7225MV-T		4		X7S	2.2 μ	±20	10	150	0.5±0.05	R
AWK107 C6475MV-T				X6S	4.7 μ	±20	10	150	0.5±0.05	R
PWK107 C6106MV-T		2.5		X6S	10 μ	±20	10	150	0.5±0.05	R

▶ 本产品目录根据版面大小, 仅记载了代表性产品规格, 若考虑使用本公司产品时, 请确认供货规格型号明细表中的详细规格。
有关各商品的详细信息(特性图、可靠性信息、使用时的注意事项等), 请参阅本公司网站(<http://www.ty-top.com/>)。

■ 型号一览

● 212型

【温度特性 BJ : X5R】厚度 0.85mm(D)

型号1	型号2	额定电压[V]	温度特性		静电容量 [F]	静电容量允许偏差 [%]	tan δ [%]	高温负载	厚度*3 [mm]	焊接方式 R:回流焊 W:波峰焊
								额定电压 x %		
TWK212 BJ475□D-T		25		X5R	4.7 μ	±10, ±20	10	150	0.85±0.10	R
EWK212 BJ106MD-T		16		X5R	10 μ	±20	10	150	0.85±0.10	R
LWK212 BJ475□D-T		10		X5R	4.7 μ	±10, ±20	10	150	0.85±0.10	R
LWK212 BJ106MD-T			X5R	10 μ	±20	10	150	0.85±0.10	R	
JWK212 BJ226MD-T		6.3		X5R	22 μ	±20	10	150	0.85±0.10	R

【温度特性 B7 : X7R, C6 : X6S】厚度 0.85mm(D)

型号1	型号2	额定电压[V]	温度特性		静电容量 [F]	静电容量允许偏差 [%]	tan δ [%]	高温负载	厚度*3 [mm]	焊接方式 R:回流焊 W:波峰焊
								额定电压 x %		
TWK212 B7225□D-T		25		X7R	2.2 μ	±10, ±20	5	150	0.85±0.10	R
EWK212 C6475□D-T		16		X6S	4.7 μ	±10, ±20	10	150	0.85±0.10	R
LWK212 C6106MD-T		10		X6S	10 μ	±20	10	150	0.85±0.10	R
AWK212 C6226MD-T		4		X6S	22 μ	±20	10	150	0.85±0.10	R

▶ 本产品目录根据版面大小，仅记载了代表性产品规格，若考虑使用本公司产品时，请确认供货规格型号明细表中的详细规格。
有关各商品的详细信息(特性图、可靠性信息、使用时的注意事项等)，请参阅本公司网站(<http://www.ty-top.com/>)。

Multilayer Ceramic Capacitors

PACKAGING

① Minimum Quantity

● Taped package

Type(EIA)	Thickness		Standard quantity [pcs]		
	mm	code	Paper tape	Embossed tape	
□MK042(01005)	0.2	C, D	—	40000	
□VS042(01005)	0.2	C			
□MK063(0201)	0.3	P, T	15000	—	
□WK105(0204) ※	0.3	P	10000		
□MK105(0402)	0.2	C	20000		
	0.3	P	15000		
	0.5	V	10000		
□VK105(0402) ※	0.5	W			
□MK107(0603)	0.45	K	4000		4000
□WK107(0306) ※	0.5	V	—		
□MR107(0603)	0.8	A	4000		
□MK212(0805)	0.45	K			
□WK212(0508) ※	0.85	D			
□MR212(0805)	1.25	G	—	3000	
□MK316(1206)	0.85	D	4000	—	
	1.15	F	—	3000	
	1.25	G	—	2000	
□MK325(1210)	0.85	D	—	2000	
	1.15	F			
	1.9	N			
	2.0max.	Y			
	2.5	M			
□MR325(1210)	2.5	M	—	500(T), 1000(P)	
□MK432(1812)	2.5	M	—	500	

Note : ※ LW Reverse type.

② Taping material

※No bottom tape for pressed carrier tape

● Card board carrier tape

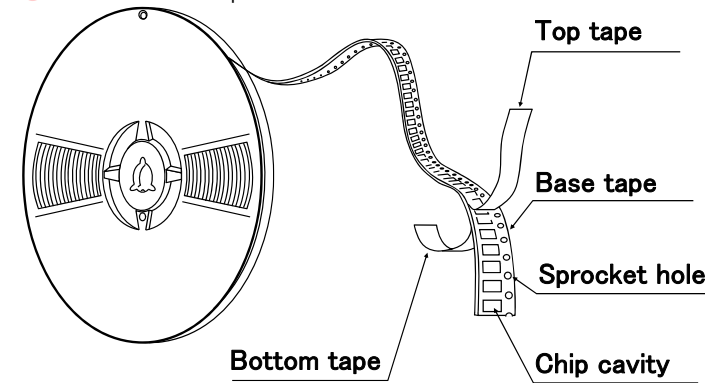

● Embossed tape

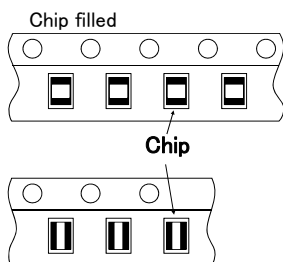
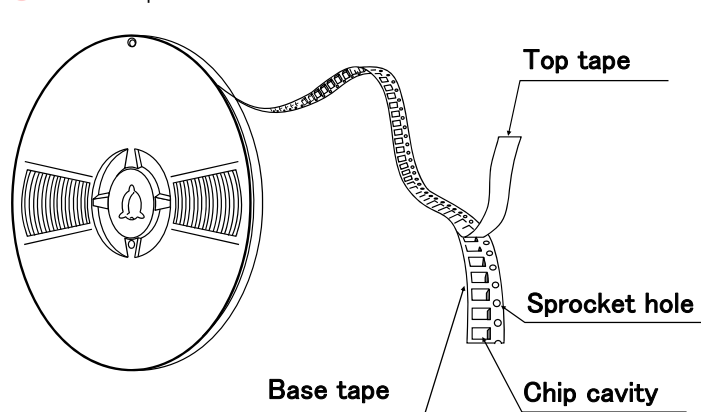

▶ This catalog contains the typical specification only due to the limitation of space. When you consider the purchase of our products, please check our specification. For details of each product (characteristics graph, reliability information, precautions for use, and so on), see our Web site (<http://www.ty-top.com/>).

③ Representative taping dimensions

● Paper Tape (8mm wide)

● Pressed carrier tape (2mm pitch)

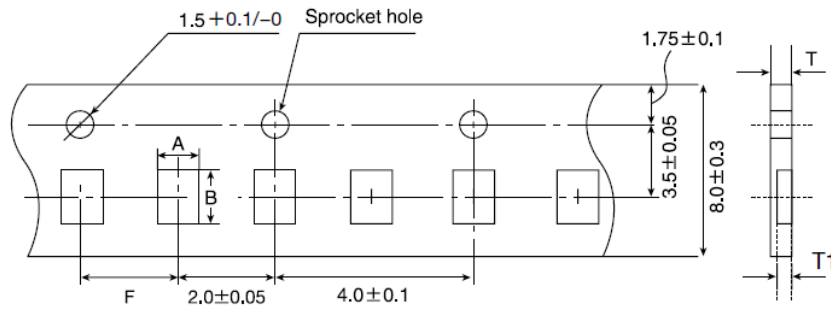

Unit : mm

Type(EIA)	Chip Cavity		Insertion Pitch F	Tape Thickness	
	A	B		T	T1
□MK063(0201)	0.37	0.67	2.0±0.05	0.45max.	0.42max.
□WK105(0204) ※	0.65	1.15		0.4max.	0.3max.
□MK105(0402) (*1 C)				0.45max.	0.42max.
□MK105(0402) (*1 P)					

Note *1 Thickness, C:0.2mm ,P:0.3mm. ※ LW Reverse type.

Unit : mm

● Punched carrier tape (2mm pitch)

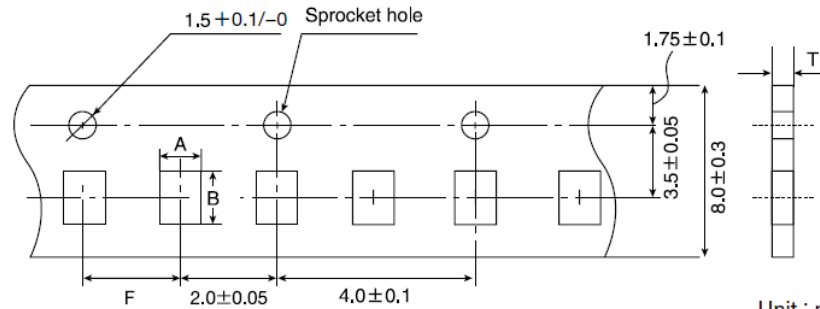

Unit : mm

Type(EIA)	Chip Cavity		Insertion Pitch F	Tape Thickness
	A	B		T
□MK105 (0402)	0.65	1.15	2.0±0.05	0.8max.
□VK105 (0402)				

Unit : mm

● Punched carrier tape (4mm pitch)

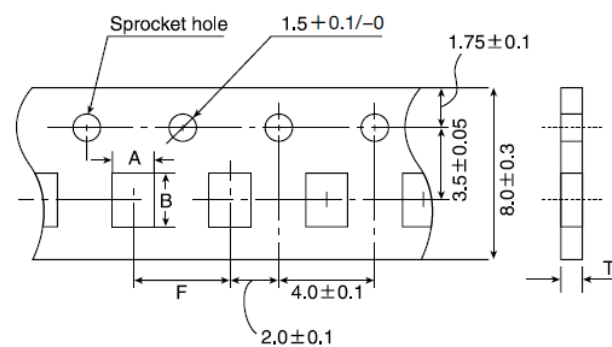

Unit : mm

Type(EIA)	Chip Cavity		Insertion Pitch F	Tape Thickness
	A	B		T
□MK107(0603)	1.0	1.8	4.0±0.1	1.1max.
□WK107(0306) ※				
□MR107(0603)				
□MK212(0805)	1.65	2.4		1.1max.
□WK212(0508) ※				
□MK316(1206)	2.0	3.6		

Note : Taping size might be different depending on the size of the product. ※ LW Reverse type.

Unit : mm

● Embossed tape (4mm wide)

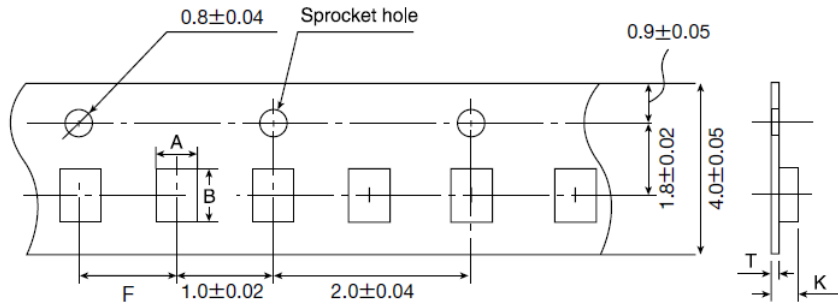

Unit : mm

Type(EIA)	Chip Cavity		Insertion Pitch F	Tape Thickness	
	A	B		K	T
□MK042(01005)	0.23	0.43	1.0±0.02	0.5max.	0.25max.
□VS042(01005)					

Unit : mm

● Embossed tape (8mm wide)

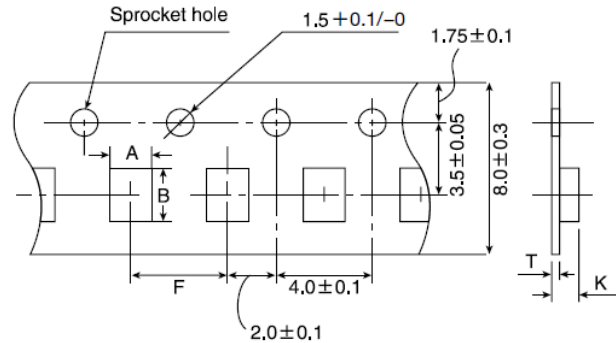

Unit : mm

Type(EIA)	Chip Cavity		Insertion Pitch F	Tape Thickness	
	A	B		K	T
□WK107(0306) ※	1.0	1.8	4.0±0.1	1.3max.	0.25±0.1
□MK212(0805)	1.65	2.4		3.4max.	0.6max.
□MR212(0805)					
□MK316(1206)	2.0	3.6			
□MR316(1206)					
□MK325(1210)	2.8	3.6			
□MR325(1210)					

Note: ※ LW Reverse type.

Unit : mm

● Embossed tape (12mm wide)

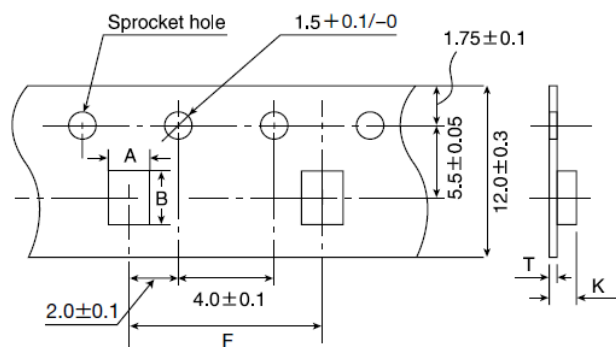

Unit : mm

Type(EIA)	Chip Cavity		Insertion Pitch F	Tape Thickness	
	A	B		K	T
□MK432(1812)	3.7	4.9	8.0±0.1	4.0max.	0.6max.

Unit : mm

▶ This catalog contains the typical specification only due to the limitation of space. When you consider the purchase of our products, please check our specification. For details of each product (characteristics graph, reliability information, precautions for use, and so on), see our Web site (<http://www.ty-top.com/>).

④Trailer and Leader

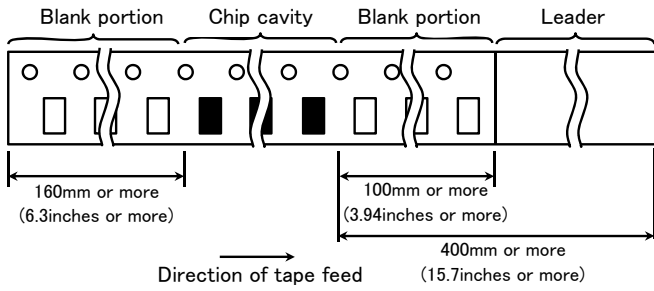

⑤Reel size

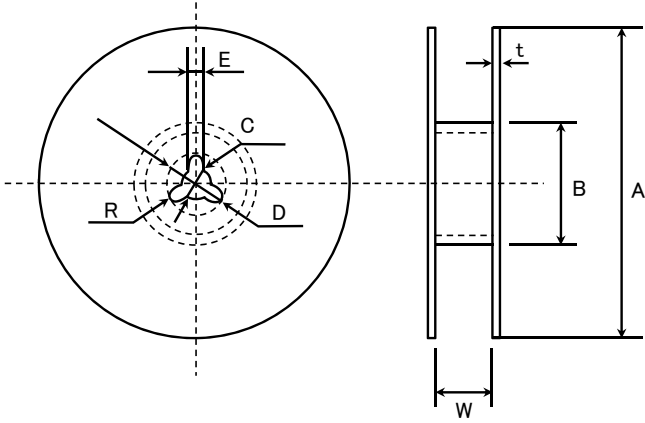

A	B	C	D	E	R
$\phi 178 \pm 2.0$	$\phi 50 \text{min.}$	$\phi 13.0 \pm 0.2$	$\phi 21.0 \pm 0.8$	2.0 ± 0.5	1.0
	T	W			
4mm wide tape	1.5max.	5 ± 1.0			
8mm wide tape	2.5max.	10 ± 1.5			
12mm wide tape	2.5max.	14 ± 1.5			

Unit: mm

⑥Top Tape Strength

The top tape requires a peel-off force of 0.1 to 0.7N in the direction of the arrow as illustrated below.

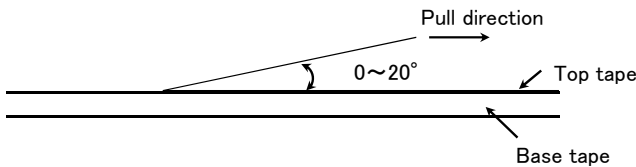

⑦Bulk Cassette

The exchange of individual specification is necessary.
Please contact Taiyo Yuden sales channels.

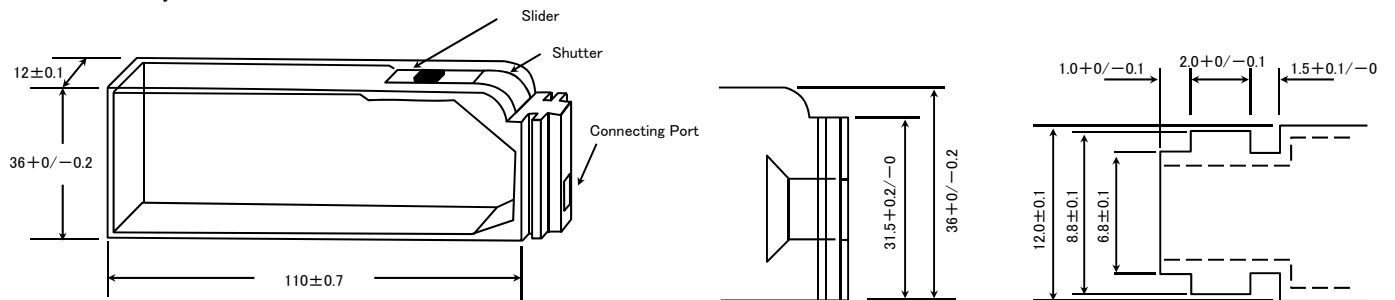

Unit: mm

Multilayer Ceramic Capacitors

RELIABILITY DATA

1. Operating Temperature Range

Specified Value	Temperature Compensating (Class1)	Standard	-55 to +125°C	
		High Frequency Type		
Specified Value	High Permittivity (Class2)		Specification	Temperature Range
		BJ	B	-25 to +85°C
			X5R	-55 to +85°C
		B7	X7R	-55 to +125°C
		C6	X6S	-55 to +105°C
		C7	X7S	-55 to +125°C
		LD(※)	X5R	-55 to +85°C
		F	F	-25 to +85°C
Y5V	-30 to +85°C			

Note: ※LD Low distortion high value multilayer ceramic capacitor

2. Storage Conditions

Specified Value	Temperature Compensating (Class1)	Standard	-55 to +125°C	
		High Frequency Type		
Specified Value	High Permittivity (Class2)		Specification	Temperature Range
		BJ	B	-25 to +85°C
			X5R	-55 to +85°C
		B7	X7R	-55 to +125°C
		C6	X6S	-55 to +105°C
		C7	X7S	-55 to +125°C
		LD(※)	X5R	-55 to +85°C
		F	F	-25 to +85°C
Y5V	-30 to +85°C			

Note: ※LD Low distortion high value multilayer ceramic capacitor

3. Rated Voltage

Specified Value	Temperature Compensating (Class1)	Standard	50VDC, 25VDC, 16VDC
		High Frequency Type	50VDC, 25VDC, 16VDC
	High Permittivity (Class2)		50VDC, 35VDC, 25VDC, 16VDC, 10VDC, 6.3VDC, 4VDC, 2.5VDC

4. Withstanding Voltage (Between terminals)

Specified Value	Temperature Compensating (Class1)	Standard	No breakdown or damage
		High Frequency Type	
	High Permittivity (Class2)		
Test Methods and Remarks		Class 1	Class 2
	Applied voltage	Rated voltage × 3	Rated voltage × 2.5
	Duration	1 to 5 sec.	
	Charge/discharge current	50mA max.	

5. Insulation Resistance

Specified Value	Temperature Compensating (Class1)	Standard	10000 MΩ min.
		High Frequency Type	
	High Permittivity (Class2) Note 1		C ≤ 0.047 μF : 10000 MΩ min. C > 0.047 μF : 500MΩ · μF
Test Methods and Remarks	Applied voltage	: Rated voltage	
	Duration	: 60 ± 5 sec.	
	Charge/discharge current	: 50mA max.	

▶ This catalog contains the typical specification only due to the limitation of space. When you consider the purchase of our products, please check our specification. For details of each product (characteristics graph, reliability information, precautions for use, and so on), see our Web site (<http://www.ty-top.com/>).

6. Capacitance (Tolerance)					
Specified Value	Temperature Compensating(Class1)	Standard	C□	0.2pF ≤ C ≤ 5pF : ±0.25pF	
			U□	0.2pF ≤ C ≤ 10pF : ±0.5pF	
		SL	C > 10pF : ±5% or ±10%		
		High Frequency Type	CH	0.2pF ≤ C ≤ 2pF : ±0.1pF C > 2pF : ±5%	
	High Permittivity (Class2)		BJ, B7, C6, C7, LD(※) : ±10% or ±20%, F : +80/-20% Note: ※LD Low distortion high value multilayer ceramic capacitor		
Test Methods and Remarks			Class 1		
			Standard	High Frequency Type	
	Preconditioning		None		
	Measuring frequency		1MHz ± 10%		
	Measuring voltage Note		0.5 to 5Vrms		
Bias application		None			
				Class 2	
				C ≤ 10 μF	
				C > 10 μF	
Preconditioning		Thermal treatment (at 150°C for 1hr) Note 2			
Measuring frequency		1kHz ± 10%			
Measuring voltage Note		1 ± 0.2Vrms			
Bias application		0.5 ± 0.1Vrms			

7. Q or Dissipation Factor					
Specified Value	Temperature Compensating(Class1)	Standard	C < 30pF : Q ≥ 400 + 20C C ≥ 30pF : Q ≥ 1000 (C: Nominal capacitance)		
			High Frequency Type	Refer to detailed specification	
		High Permittivity (Class2) Note 1		BJ, B7, C6, C7: 2.5% max., F: 7% max.	
Test Methods and Remarks			Class 1		
			Standard	High Frequency Type	
	Preconditioning		None		
	Measuring frequency		1MHz ± 10%		
	Measuring voltage Note 1		0.5 to 5Vrms		
Bias application		None			
				Class 2	
				C ≤ 10 μF	
				C > 10 μF	
Preconditioning		Thermal treatment (at 150°C for 1hr) Note 2			
Measuring frequency		1kHz ± 10%			
Measuring voltage Note 1		1 ± 0.2Vrms			
Bias application		0.5 ± 0.1Vrms			
High Frequency Type					
Measuring equipment		: HP4291A			
Measuring jig		: HP16192A			

8. Temperature Characteristic (Without voltage application)							
Specified Value	Temperature Compensating(Class1)	Standard	Temperature Characteristic [ppm/°C]				
			C□ : 0	CG, CH, CJ, CK			
			High Frequency Type	Temperature Characteristic [ppm/°C]			
			U□ : -750	UJ, UK			
			SL : +350 to -1000				
			Tolerance [ppm/°C]				
			G : ±30				
			H : ±60				
			J : ±120				
			K : ±250				
			H : ±60				
	High Permittivity (Class2)		Specification	Capacitance change	Reference temperature	Temperature Range	
			BJ	B	±10%	20°C	-25 to +85°C
				X5R	±15%	25°C	-55 to +85°C
				X7R	±15%	25°C	-55 to +125°C
				X6S	±22%	25°C	-55 to +105°C
				X7S	±22%	25°C	-55 to +125°C
				LD(※)	±15%	25°C	-55 to +85°C
				F	+30/-80%	20°C	-25 to +85°C
				Y5V	+22/-82%	25°C	-30 to +85°C
				Note : ※LD Low distortion high value multilayer ceramic capacitor			
Test Methods and Remarks	Class 1						
	Capacitance at 20°C and 85°C shall be measured in thermal equilibrium, and the temperature characteristic shall be calculated from the following equation.						
	$\frac{(C_{85} - C_{20})}{C_{20} \times \Delta T} \times 10^6 (\text{ppm}/^\circ\text{C}) \quad \Delta T = 65$						
	Class 2						
	Capacitance at each step shall be measured in thermal equilibrium, and the temperature characteristic shall be calculated from the following equation.						
	Step	B, F	X5R, X7R, X6S, X7S, Y5V				
	1	Minimum operating temperature					
	2	20°C	25°C				
	3	Maximum operating temperature					

▶ This catalog contains the typical specification only due to the limitation of space. When you consider the purchase of our products, please check our specification. For details of each product (characteristics graph, reliability information, precautions for use, and so on), see our Web site (<http://www.ty-top.com/>).

$$\frac{(C-C_2)}{C_2} \times 100(\%)$$

C : Capacitance in Step 1 or Step 3
C2 : Capacitance in Step 2

9. Deflection

Specified Value	Temperature Compensating (Class1)	Standard	Appearance : No abnormality Capacitance change : Within $\pm 5\%$ or ± 0.5 pF, whichever is larger.
		High Frequency Type	Appearance : No abnormality Capacitance change : Within ± 0.5 pF
	High Permittivity (Class2)		Appearance : No abnormality Capacitance change : Within $\pm 12.5\%$ (BJ, B7, C6, C7, LD(※)) Within $\pm 30\%$ (F) Note: ※LD Low distortion high value multilayer ceramic capacitor

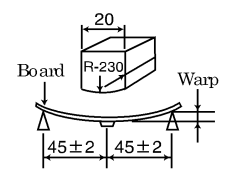
Test Methods and Remarks	Multilayer Ceramic Capacitors			
		042, 063, ※105 Type		The other types
	Board	Glass epoxy-resin substrate		
	Thickness	0.8mm		1.6mm
	Warp	1mm		
Duration	10 sec.			
	※105 Type thickness, C: 0.2mm, P: 0.3mm.			

10. Body Strength

Specified Value	Temperature Compensating (Class1)	Standard	—
		High Frequency Type	No mechanical damage.
	High Permittivity (Class2)		—

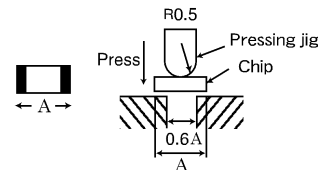
Test Methods and Remarks	High Frequency Type	
	Applied force : 5N Duration : 10 sec.	

11. Adhesive Strength of Terminal Electrodes

Specified Value	Temperature Compensating (Class1)	Standard	No terminal separation or its indication.
		High Frequency Type	
	High Permittivity (Class2)		

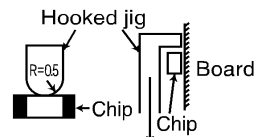
Test Methods and Remarks	Multilayer Ceramic Capacitors			
		042, 063 Type		105 Type or more
	Applied force	2N		5N
	Duration	30 ± 5 sec.		

12. Solderability

Specified Value	Temperature Compensating (Class1)	Standard	At least 95% of terminal electrode is covered by new solder.
		High Frequency Type	
	High Permittivity (Class2)		

Test Methods and Remarks		Eutectic solder	Lead-free solder
	Solder type	H60A or H63A	Sn-3.0Ag-0.5Cu
	Solder temperature	230 ± 5°C	245 ± 3°C
	Duration	4 ± 1 sec.	

▶ This catalog contains the typical specification only due to the limitation of space. When you consider the purchase of our products, please check our specification. For details of each product (characteristics graph, reliability information, precautions for use, and so on), see our Web site (<http://www.ty-top.com/>).

13. Resistance to Soldering

Specified Value	Temperature Compensating (Class1)	Standard	Appearance : No abnormality Capacitance change : Within $\pm 2.5\%$ or $\pm 0.25\text{pF}$, whichever is larger. Q : Initial value Insulation resistance : Initial value Withstanding voltage (between terminals) : No abnormality
		High Frequency Type	Appearance : No abnormality Capacitance change : Within $\pm 2.5\%$ Q : Initial value Insulation resistance : Initial value Withstanding voltage (between terminals) : No abnormality
	High Permittivity (Class2) Note 1		Appearance : No abnormality Capacitance change : Within $\pm 7.5\%$ (BJ, B7, C6, C7, LD(※)) Within $\pm 20\%$ (F) Dissipation factor : Initial value Insulation resistance : Initial value Withstanding voltage (between terminals) : No abnormality Note: ※LD Low distortion high value multilayer ceramic capacitor

Test Methods and Remarks	Class 1			
		042, 063 Type	105 Type	
	Preconditioning	None		
	Preheating	150°C, 1 to 2 min.	80 to 100°C, 2 to 5 min. 150 to 200°C, 2 to 5 min.	
	Solder temp.	270 \pm 5°C		
	Duration	3 \pm 0.5 sec.		
	Recovery	6 to 24 hrs (Standard condition) Note 5		
	Class 2			
		042, 063 Type	105, 107, 212 Type	316, 325 Type
	Preconditioning	Thermal treatment (at 150°C for 1 hr) Note 2		
	Preheating	150°C, 1 to 2 min.	80 to 100°C, 2 to 5 min. 150 to 200°C, 2 to 5 min.	80 to 100°C, 5 to 10 min. 150 to 200°C, 5 to 10 min.
	Solder temp.	270 \pm 5°C		
	Duration	3 \pm 0.5 sec.		
	Recovery	24 \pm 2 hrs (Standard condition) Note 5		

14. Temperature Cycle (Thermal Shock)

Specified Value	Temperature Compensating (Class1)	Standard	Appearance : No abnormality Capacitance change : Within $\pm 2.5\%$ or $\pm 0.25\text{pF}$, whichever is larger. Q : Initial value Insulation resistance : Initial value Withstanding voltage (between terminals) : No abnormality
		High Frequency Type	Appearance : No abnormality Capacitance change : Within $\pm 0.25\text{pF}$ Q : Initial value Insulation resistance : Initial value Withstanding voltage (between terminals) : No abnormality
	High Permittivity (Class2) Note 1		Appearance : No abnormality Capacitance change : Within $\pm 7.5\%$ (BJ, B7, C6, C7, LD(※)) Within $\pm 20\%$ (F) Dissipation factor : Initial value Insulation resistance : Initial value Withstanding voltage (between terminals) : No abnormality Note: ※LD Low distortion high value multilayer ceramic capacitor

Test Methods and Remarks	Class 1		Class 2		
	Preconditioning	None		Thermal treatment (at 150°C for 1 hr) Note 2	
	1 cycle	Step	Temperature (°C)	Time (min.)	
		1	Minimum operating temperature	30 \pm 3	
		2	Normal temperature	2 to 3	
		3	Maximum operating temperature	30 \pm 3	
4	Normal temperature	2 to 3			
Number of cycles	5 times				
Recovery	6 to 24 hrs (Standard condition) Note 5		24 \pm 2 hrs (Standard condition) Note 5		

▶ This catalog contains the typical specification only due to the limitation of space. When you consider the purchase of our products, please check our specification.
For details of each product (characteristics graph, reliability information, precautions for use, and so on), see our Web site (<http://www.ty-top.com/>).

15. Humidity (Steady State)					
Specified Value	Temperature Compensating (Class1)	Standard	Appearance : No abnormality Capacitance change : Within $\pm 5\%$ or $\pm 0.5\text{pF}$, whichever is larger. Q : $C < 10\text{pF} : Q \geq 200 + 10C$ $10 \leq C < 30\text{pF} : Q \geq 275 + 2.5C$ $C \geq 30\text{pF} : Q \geq 350$ (C: Nominal capacitance) Insulation resistance : 1000 M Ω min.		
		High Frequency Type	Appearance : No abnormality Capacitance change : Within $\pm 0.5\text{pF}$, Insulation resistance : 1000 M Ω min.		
	High Permittivity (Class2) Note 1	Appearance : No abnormality Capacitance change : Within $\pm 12.5\%$ (BJ, B7, C6, C7, LD(※)) Within $\pm 30\%$ (F) Dissipation factor : 5.0% max. (BJ, B7, C6, C7, LD(※)) 11.0% max. (F) Insulation resistance : 50 M Ω μF or 1000 M Ω whichever is smaller. Note: ※LD Low distortion high value multilayer ceramic capacitor			
Test Methods and Remarks		Class 1		Class 2	
		Standard	High Frequency Type	All items	
	Preconditioning	None			Thermal treatment (at 150°C for 1 hr) Note 2
	Temperature	40 \pm 2°C	60 \pm 2°C	40 \pm 2°C	
	Humidity	90 to 95%RH			90 to 95%RH
	Duration	500 + 24 / - 0 hrs			500 + 24 / - 0 hrs
	Recovery	6 to 24 hrs (Standard condition) Note 5			24 \pm 2 hrs (Standard condition) Note 5

16. Humidity Loading					
Specified Value	Temperature Compensating (Class1)	Standard	Appearance : No abnormality Capacitance change : Within $\pm 7.5\%$ or $\pm 0.75\text{pF}$, whichever is larger. Q : $C < 30\text{pF} : Q \geq 100 + 10C/3$ $C \geq 30\text{pF} : Q \geq 200$ (C: Nominal capacitance) Insulation resistance : 500 M Ω min.		
		High Frequency Type	Appearance : No abnormality Capacitance change : $C \leq 2\text{pF} : \text{Within } \pm 0.4 \text{ pF}$ $C > 2\text{pF} : \text{Within } \pm 0.75 \text{ pF}$ (C: Nominal capacitance) Insulation resistance : 500 M Ω min.		
	High Permittivity (Class2) Note 1	Appearance : No abnormality Capacitance change : Within $\pm 12.5\%$ (BJ, B7, C6, C7, LD(※)) Within $\pm 30\%$ (F) Dissipation factor : 5.0% max. (BJ, B7, C6, C7, LD(※)) 11.0% max. (F) Insulation resistance : 25 M Ω μF or 500 M Ω , whichever is smaller. Note: ※LD Low distortion high value multilayer ceramic capacitor			
Test Methods and Remarks		Class 1		Class 2	
		Standard	High Frequency Type	All items	
	Preconditioning	None			Voltage treatment (Rated voltage are applied for 1 hour at 40°C) Note 3
	Temperature	40 \pm 2°C	60 \pm 2°C	40 \pm 2°C	
	Humidity	90 to 95%RH			90 to 95%RH
	Duration	500 + 24 / - 0 hrs			500 + 24 / - 0 hrs
	Applied voltage	Rated voltage			Rated voltage
	Charge/discharge current	50mA max.			50mA max.
Recovery	6 to 24 hrs (Standard condition) Note 5			24 \pm 2 hrs (Standard condition) Note 5	

▶ This catalog contains the typical specification only due to the limitation of space. When you consider the purchase of our products, please check our specification.
For details of each product (characteristics graph, reliability information, precautions for use, and so on), see our Web site (<http://www.ty-top.com/>).

17. High Temperature Loading

Specified Value	Temperature Compensating (Class1)	Standard	Appearance : No abnormality Capacitance change : Within $\pm 3\%$ or $\pm 0.3\text{pF}$, whichever is larger. Q : $C < 10\text{pF}$: $Q \geq 200 + 10C$ $10 \leq C < 30\text{pF}$: $Q \geq 275 + 2.5C$ $C \geq 30\text{pF}$: $Q \geq 350$ (C: Nominal capacitance) Insulation resistance : 1000 M Ω min.				
		High Frequency Type	Appearance : No abnormality Capacitance change : Within $\pm 3\%$ or $\pm 0.3\text{pF}$, whichever is larger. Insulation resistance : 1000 M Ω min.				
	High Permittivity (Class2) Note 1		Appearance : No abnormality Capacitance change : Within $\pm 12.5\%$ (BJ, B7, C6, C7, LD(※)) Within $\pm 30\%$ (F) Dissipation factor : 5.0% max. (BJ, B7, C6, C7, LD(※)) 11.0% max. (F) Insulation resistance : 50 M Ω μF or 1000 M Ω , whichever is smaller. Note: ※LD Low distortion high value multilayer ceramic capacitor				
Test Methods and Remarks		Class 1		Class 2			
		Standard	High Frequency Type	BJ, LD(※), F	C6	B7, C7	
	Preconditioning	None			Voltage treatment (Twice the rated voltage shall be applied for 1 hour at 85°C, 105°C or 125°C) Note 3, 4		
	Temperature	Maximum operating temperature			Maximum operating temperature		
	Duration	1000+48/-0 hrs			1000+48/-0 hrs		
	Applied voltage	Rated voltage $\times 2$			Rated voltage $\times 2$ Note 4		
	Charge/discharge current	50mA max.			50mA max.		
	Recovery	6 to 24hr (Standard condition) Note 5			24 ± 2 hrs (Standard condition) Note 5		
Note: ※LD Low distortion high value multilayer ceramic capacitor							

Note 1 The figures indicate typical specifications. Please refer to individual specifications in detail.

Note 2 Thermal treatment : Initial value shall be measured after test sample is heat-treated at 150+0/-10°C for an hour and kept at room temperature for 24 ± 2 hours.

Note 3 Voltage treatment : Initial value shall be measured after test sample is voltage-treated for an hour at both the temperature and voltage specified in the test conditions, and kept at room temperature for 24 ± 2 hours.

Note 4 150% of rated voltage is applicable to some items. Please refer to their specifications for further information.

Note 5 Standard condition: Temperature: 5 to 35°C, Relative humidity: 45 to 85 % RH, Air pressure: 86 to 106kPa When there are questions concerning measurement results, in order to provide correlation data, the test shall be conducted under the following condition.

Temperature: 20 ± 2 °C, Relative humidity: 60 to 70 % RH, Air pressure: 86 to 106kPa Unless otherwise specified, all the tests are conducted under the "standard condition".

Super Low Distortion Multilayer Ceramic Capacitors (CFCAP™)

RELIABILITY DATA

1. Operating Temperature Range

Specified Value	-55 to +125°C
-----------------	---------------

2. Storage Temperature Range

Specified Value	-55 to +125°C
-----------------	---------------

3. Rated Voltage

Specified Value	6.3VDC, 10VDC, 16VDC, 25VDC, 35VDC, 50VDC
-----------------	---

4. Dielectric Withstanding Voltage (Between terminals)

Specified Value	No breakdown or damage	
Test Methods and Remarks	Applied voltage	: Rated voltage × 3
	Duration	: 1 to 5 sec.
	Charge/discharge current	: 50mA max.

5. Insulation Resistance

Specified Value	10000 MΩ or 500MΩ μ F, whichever is smaller	
Test Methods and Remarks	Applied voltage	: Rated voltage
	Duration	: 60±5 sec.
	Charge/discharge current	: 50mA max.

6. Capacitance (Tolerance)

Specified Value	±10%	
Test Methods and Remarks	Measuring frequency	: 1kHz±10%
	Measuring voltage	: 1±0.2Vrms
	Bias application	: None

7. Dissipation Factor

Specified Value	0.1%max	
Test Methods and Remarks	Measuring frequency	: 1kHz±10%
	Measuring voltage	: 1±0.2Vrms
	Bias application	: None

8. Bending Strength

Specified Value	Appearance	: No abnormality
	Capacitance change	: ±5%
Test Methods and Remarks	Warp	: 1mm
	Speed	: 0.5mm/second
	Duration	: 10 seconds
	Test board	: glass epoxy resin substrate
	Thickness	: 1.6mm

(Unit: mm)

Capacitance measurement shall be conducted with the board bent.

9. Adhesive Force of Terminal Electrodes

Specified Value	Terminal electrodes shall be no exfoliation or a sign of exfoliation.	
Test Methods and Remarks	Applied force	: 5N
	Duration	: 30 ±5 seconds

▶ This catalog contains the typical specification only due to the limitation of space. When you consider the purchase of our products, please check our specification. For details of each product (characteristics graph, reliability information, precautions for use, and so on), see our Web site (<http://www.ty-top.com/>) .

10. Solderability			
Specified Value	At least 95% of terminal electrode is covered by new solder.		
Test Methods and Remarks		Eutectic solder	Lead-free solder
	Solder type	H60A or H63A	Sn-3.0Ag-0.5Cu
	Solder temperature	230±5°C	245±3°C
	Duration	4±1 sec.	
11. Resistance to Soldering Heat			
Specified Value	Appearance	: No abnormality	
	Capacitance change	: ±2.5% max.	
	Dissipation factor	: Initial value	
	Insulation resistance	: Initial value	
	Withstanding voltage	(between terminals) : No abnormality	
Test Methods and Remarks	Solder temp.	: 270 ±5°C	
	Duration	: 3 ±0.5 sec.	
	Preheating conditions	: 80 to 100°C, 2 to 5 min. or 5 to 10 min. 150 to 200°C, 2 to 5 min. or 5 to 10 min.	
	Measurement shall be conducted	: 24±2hrs under the standard condition Note1	
12. Temperature Cycle (Thermal Shock)			
Specified Value	Appearance	: No abnormality	
	Capacitance change	: ±2.5% max	
	Dissipation factor	: Initial value	
	Insulation resistance	: Initial value	
	Withstanding voltage	(between terminals): No abnormality	
Test Methods and Remarks	Conditions for 1 cycle		
	Step	temperature (°C)	Time (min.)
	1	Minimum operating temperature	30±3 min.
	2	Normal temperature	2 to 3 min.
	3	Maximum operating temperature	30±3 min.
	4	Normal temperature	2 to 3 min.
Number of cycles: 5 times			
Measurement shall be conducted : 24±2hrs under the standard condition Note1			
13. Humidity (Steady state)			
Specified Value	Appearance	: No abnormality	
	Capacitance change	: ±5% max	
	Dissipation factor	: 0.5% max	
	Insulation resistance	: 50MΩ μ F or 1000MΩ, whichever is smaller	
Test Methods and Remarks	Temperature	: 40±2°C	
	Humidity	: 90 to 95% RH	
	Duration	: 500 +24/-0 hrs	
	Measurement shall be conducted	: 24 ±2hrs under the standard condition Note1	
14. Humidity Loading			
Specified Value	Appearance	: No abnormality	
	Capacitance change	: ±7.5% max	
	Dissipation factor	: 0.5% max	
	Insulation resistance	: 25MΩ μ F or 500MΩ, whichever is smaller	
Test Methods and Remarks	According to JIS C 5102 clause 9.9.		
	Temperature	: 40±2°C	
	Humidity	: 90 to 95% RH	
	Duration	: 500 +24/-0 hrs	
	Applied voltage	: Rated voltage	
	Charge/discharge current	: 50mA max	
	Measurement shall be conducted	: 24 ±2hrs under the standard condition Note1	

15. High Temperature Loading

Specified Value	Appearance	: No abnormality
	Capacitance change	: $\pm 3\%$ max
	Dissipation factor	: 0.35% max
	Insulation resistance	: 50M Ω μ F or 1000M Ω , whichever is smaller
Test Methods and Remarks	According to JIS C 5102 clause 9.10.	
	Temperature	: Maximum operating temperature
	Duration	: 1000 +48/−0 hrs
	Applied voltage	: Rated voltage x 2
	Charge/discharge current	: 50mA max
Measurement shall be conducted	: 24 \pm 2hrs under the standard condition Note1	

Note1 Standard condition: Temperature: 5 to 35°C, Relative humidity: 45 to 85 % RH, Air pressure: 86 to 106kPa

When there are questions concerning measurement results, in order to provide correlation data, the test shall be conducted under the following condition.

Temperature: 20 \pm 2°C, Relative humidity: 60 to 70 % RH, Air pressure: 86 to 106kPa

Unless otherwise specified, all the tests are conducted under the "standard condition".

Medium-High Voltage Multilayer Ceramic Capacitor

RELIABILITY DATA

1. Operating Temperature Range

Specified Value	X7R, X7S	: -55 to +125°C
	X5R	: -55 to +85°C
	B	: -25 to +85°C

2. Storage Temperature Range

Specified Value	X7R, X7S	: -55 to +125°C
	X5R	: -55 to +85°C
	B	: -25 to +85°C

3. Rated Voltage

Specified Value	100VDC(HMK), 250VDC(QMK), 630VDC(SMK)
-----------------	---------------------------------------

4. Withstanding Voltage (Between terminals)

Specified Value	No breakdown or damage	
Test Methods and Remarks	Applied voltage	: Rated voltage × 2.5 (HMK), Rated voltage × 2 (QMK), Rated voltage × 1.2 (SMK)
	Duration	: 1 to 5sec.
	Charge/discharge current	: 50mA max.

5. Insulation Resistance

Specified Value	100MΩ · μF or 10GΩ, whichever is smaller.	
Test Methods and Remarks	Applied voltage	: Rated voltage (HMK, QMK), 500V (SMK)
	Duration	: 60 ± 5sec.
	Charge/discharge current	: 50mA max.

6. Capacitance (Tolerance)

Specified Value	±10%, ±20%	
Test Methods and Remarks	Measuring frequency	: 1kHz ± 10%
	Measuring voltage	: 1 ± 0.2Vrms
	Bias application	: None

7. Dissipation Factor

Specified Value	3.5%max (HMK)	
	2.5%max (QMK, SMK)	
Test Methods and Remarks	Measuring frequency	: 1kHz ± 10%
	Measuring voltage	: 1 ± 0.2Vrms
	Bias application	: None

8. Temperature Characteristic of Capacitance

Specified Value	B	: ±10% (-25 to +85°C)	
	X5R	: ±15% (-55 to +85°C)	
	X7R	: ±15% (-55 to +125°C)	
	X7S	: ±22% (-55 to +125°C)	
Test Methods and Remarks	Capacitance value at each step shall be measured in thermal equilibrium, and the temperature characteristic shall be calculated from the following equation.		
	Step	B	X5R, X7R, X7S
	1	Minimum operating temperature	
	2	20°C	25°C
3	Maximum operating temperature		
$\frac{(C - C_2)}{C_2} \times 100(\%)$			
C : Capacitance value in Step 1 or Step 3			
C2 : Capacitance value in Step 2			

▶ This catalog contains the typical specification only due to the limitation of space. When you consider the purchase of our products, please check our specification. For details of each product (characteristics graph, reliability information, precautions for use, and so on), see our Web site (<http://www.ty-top.com/>).

9. Deflection

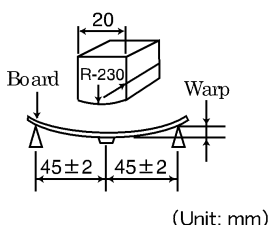
Specified Value	Appearance : No abnormality Capacitance change : Within $\pm 10\%$
Test Methods and Remarks	<p>Warp : 1mm Duration : 10sec. Test board : Glass epoxy-resin substrate Thickness : 1.6mm</p>  <p>(Unit: mm)</p> <p>Capacitance measurement shall be conducted with the board bent.</p>

10. Adhesive Strength of Terminal Electrodes

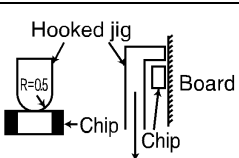
Specified Value	No terminal separation or its indication.
Test Methods and Remarks	<p>Applied force : 5N Duration : 30 ± 5sec.</p> 

11. Solderability

Specified Value	At least 95% of terminal electrode is covered by new solder		
Test Methods and Remarks		Eutectic solder	Lead-free solder
	Solder type	H60A or H63A	Sn-3.0Ag-0.5Cu
	Solder temperature	$230 \pm 5^\circ\text{C}$	$245 \pm 3^\circ\text{C}$
	Duration	4 ± 1 sec.	

12. Resistance to Soldering

Specified Value	Appearance : No abnormality Capacitance change : Within $\pm 15\%$ (HMK), $\pm 10\%$ (QMK, SMK) Dissipation factor : Initial value Insulation resistance : Initial value Withstanding voltage (between terminals) : No abnormality
Test Methods and Remarks	<p>Preconditioning : Thermal treatment (at 150°C for 1hr) Note1 Solder temperature : $270 \pm 5^\circ\text{C}$ Duration : 3 ± 0.5sec. Preheating conditions : 80 to 100°C, 2 to 5 min. 150 to 200°C, 2 to 5min. Recovery : 24 ± 2hrs under the standard condition Note3</p>

13. Temperature Cycle (Thermal Shock)

Specified Value	Appearance : No abnormality Capacitance change : Within $\pm 15\%$ (HMK), $\pm 7.5\%$ (QMK, SMK) Dissipation factor : Initial value Insulation resistance : Initial value															
Test Methods and Remarks	<p>Preconditioning : Thermal treatment (at 150°C for 1hr) Note1 Conditions for 1 cycle</p> <table border="1"> <thead> <tr> <th>Step</th> <th>Temperature ($^\circ\text{C}$)</th> <th>Time (min.)</th> </tr> </thead> <tbody> <tr> <td>1</td> <td>Minimum operating temperature</td> <td>30 ± 3min.</td> </tr> <tr> <td>2</td> <td>Normal temperature</td> <td>2 to 3min.</td> </tr> <tr> <td>3</td> <td>Maximum operating temperature</td> <td>30 ± 3min.</td> </tr> <tr> <td>4</td> <td>Normal temperature</td> <td>2 to 3min.</td> </tr> </tbody> </table> <p>Number of cycles : 5 times Recovery : 24 ± 2hrs under the standard condition Note3</p>	Step	Temperature ($^\circ\text{C}$)	Time (min.)	1	Minimum operating temperature	30 ± 3 min.	2	Normal temperature	2 to 3min.	3	Maximum operating temperature	30 ± 3 min.	4	Normal temperature	2 to 3min.
Step	Temperature ($^\circ\text{C}$)	Time (min.)														
1	Minimum operating temperature	30 ± 3 min.														
2	Normal temperature	2 to 3min.														
3	Maximum operating temperature	30 ± 3 min.														
4	Normal temperature	2 to 3min.														

▶ This catalog contains the typical specification only due to the limitation of space. When you consider the purchase of our products, please check our specification. For details of each product (characteristics graph, reliability information, precautions for use, and so on), see our Web site (<http://www.ty-top.com/>).

14. Humidity (Steady state)	
Specified Value	Appearance : No abnormality Capacitance change : Within $\pm 15\%$ Dissipation factor : 7%max (HMK), 5%max (QMK, SMK). Insulation resistance : 25M Ω μ F or 1000M Ω , whichever is smaller.
Test Methods and Remarks	Preconditioning : Thermal treatment (at 150°C for 1hr) Note1 Temperature : 40 \pm 2°C Humidity : 90 to 95%RH Duration : 500 +24/ -0 hrs Recovery : 24 \pm 2hrs under the standard condition Note3
15. Humidity Loading	
Specified Value	Appearance : No abnormality Capacitance change : Within $\pm 15\%$ Dissipation factor : 7%max (HMK), 5%max (QMK, SMK). Insulation resistance : 10M Ω μ F or 500M Ω , whichever is smaller.
Test Methods and Remarks	According to JIS 5102 clause 9.9. Preconditioning : Voltage treatment Note2 Temperature : 40 \pm 2°C Humidity : 90 to 95%RH Applied voltage : Rated voltage Charge/discharge current : 50mA max. Duration : 500 +24/ -0 hrs Recovery : 24 \pm 2hrs under the standard condition Note3
16. High Temperature Loading	
Specified Value	Appearance : No abnormality Capacitance change : Within $\pm 15\%$ Dissipation factor : 7%max (HMK), 5%max (QMK, SMK). Insulation resistance : 50M Ω μ F or 1000M Ω , whichever is smaller.
Test Methods and Remarks	According to JIS 5102 clause 9.10. Preconditioning : Voltage treatment Note2 Temperature : Maximum operating temperature Applied voltage : Rated voltage \times 2 (HMK) Rated voltage \times 1.5 (QMK) Rated voltage \times 1.2 (SMK) Charge/discharge current : 50mA max. Duration : 1000 +24/ -0 hrs Recovery : 24 \pm 2hrs under the standard condition Note3
Note1 Thermal treatment : Initial value shall be measured after test sample is heat-treated at 150 \pm 0/ -10°C for an hour and kept at room temperature for 24 \pm 2hours.	
Note2 Voltage treatment : Initial value shall be measured after test sample is voltage-treated for an hour at both the temperature and voltage specified in the test conditions, and kept at room temperature for 24 \pm 2hours.	
Note3 Standard condition : Temperature: 5 to 35°C, Relative humidity: 45 to 85 % RH, Air pressure: 86 to 106kPa When there are questions concerning measurement results, in order to provide correlation data, the test shall be conducted under the following condition. Temperature: 20 \pm 2°C, Relative humidity: 60 to 70 % RH, Air pressure: 86 to 106kPa Unless otherwise specified, all the tests are conducted under the "standard condition".	

Precautions on the use of Multilayer Ceramic Capacitors

PRECAUTIONS

1. Circuit Design

- ◆Verification of operating environment, electrical rating and performance**
1. A malfunction of equipment in fields such as medical, aerospace, nuclear control, etc. may cause serious harm to human life or have severe social ramifications.
Therefore, any capacitors to be used in such equipment may require higher safety and reliability, and shall be clearly differentiated from them used in general purpose applications.
- ◆Operating Voltage (Verification of Rated voltage)**
1. The operating voltage for capacitors must always be their rated voltage or less.
If an AC voltage is loaded on a DC voltage, the sum of the two peak voltages shall be the rated voltage or less.
For a circuit where an AC or a pulse voltage may be used, the sum of their peak voltages shall also be the rated voltage or less.
 2. Even if an applied voltage is the rated voltage or less reliability of capacitors may be deteriorated in case that either a high frequency AC voltage or a pulse voltage having rapid rise time is used in a circuit.

2. PCB Design

- ◆Pattern configurations (Design of Land-patterns)**
1. When capacitors are mounted on PCBs, the amount of solder used (size of fillet) can directly affect the capacitor performance.
Therefore, the following items must be carefully considered in the design of land patterns:
 - (1) Excessive solder applied can cause mechanical stresses which lead to chip breaking or cracking. Therefore, please consider appropriate land-patterns for proper amount of solder.
 - (2) When more than one component are jointly soldered onto the same land, each component's soldering point shall be separated by solder-resist.
- ◆Pattern configurations (Capacitor layout on PCBs)**
- After capacitors are mounted on boards, they can be subjected to mechanical stresses in subsequent manufacturing processes (PCB cutting, board inspection, mounting of additional parts, assembly into the chassis, wave soldering of the boards, etc.). For this reason, land pattern configurations and positions of capacitors shall be carefully considered to minimize stresses.

- ◆Pattern configurations (Design of Land-patterns)**
- The following diagrams and tables show some examples of recommended land patterns to prevent excessive solder amounts.

(1) Recommended land dimensions for typical chip capacitors

● Multilayer Ceramic Capacitors : Recommended land dimensions (unit: mm)

Wave-soldering

Type		107	212	316	325
Size	L	1.6	2.0	3.2	3.2
	W	0.8	1.25	1.6	2.5
A		0.8 to 1.0	1.0 to 1.4	1.8 to 2.5	1.8 to 2.5
B		0.5 to 0.8	0.8 to 1.5	0.8 to 1.7	0.8 to 1.7
C		0.6 to 0.8	0.9 to 1.2	1.2 to 1.6	1.8 to 2.5

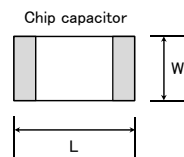
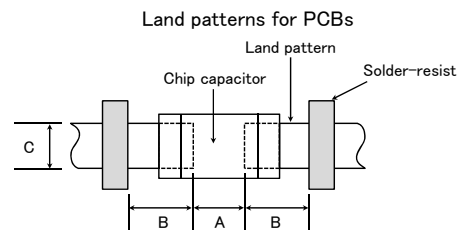

Reflow-soldering

Type		042	063	105	107	212	316	325	432
Size	L	0.4	0.6	1.0	1.6	2.0	3.2	3.2	4.5
	W	0.2	0.3	0.5	0.8	1.25	1.6	2.5	3.2
A		0.15 to 0.25	0.20 to 0.30	0.45 to 0.55	0.8 to 1.0	0.8 to 1.2	1.8 to 2.5	1.8 to 2.5	2.5 to 3.5
B		0.15 to 0.20	0.20 to 0.30	0.40 to 0.50	0.6 to 0.8	0.8 to 1.2	1.0 to 1.5	1.0 to 1.5	1.5 to 1.8
C		0.15 to 0.30	0.25 to 0.40	0.45 to 0.55	0.6 to 0.8	0.9 to 1.6	1.2 to 2.0	1.8 to 3.2	2.3 to 3.5

Note: Recommended land size might be different according to the allowance of the size of the product.

● LWDC: Recommended land dimensions for reflow-soldering (unit: mm)

Type		105	107	212
Size	L	0.52	0.8	1.25
	W	1.0	1.6	2.0
A		0.18 to 0.22	0.25 to 0.3	0.5 to 0.7
B		0.2 to 0.25	0.3 to 0.4	0.4 to 0.5
C		0.9 to 1.1	1.5 to 1.7	1.9 to 2.1

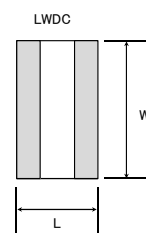

Technical considerations

▶ This catalog contains the typical specification only due to the limitation of space. When you consider the purchase of our products, please check our specification. For details of each product (characteristics graph, reliability information, precautions for use, and so on), see our Web site (<http://www.ty-top.com/>).

(2) Examples of good and bad solder application

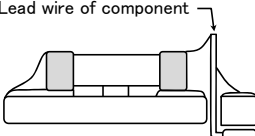
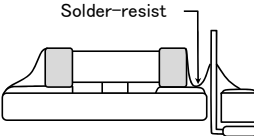
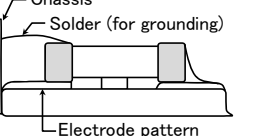
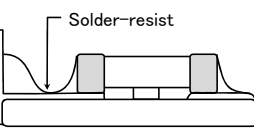
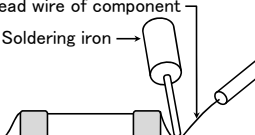
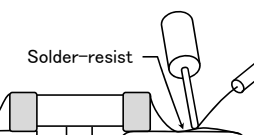
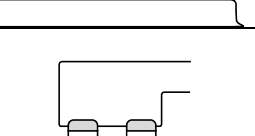
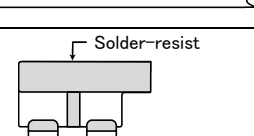
Item	Not recommended	Recommended
Mixed mounting of SMD and leaded components		
Component placement close to the chassis		
Hand-soldering of leaded components near mounted components		
Horizontal component placement		

◆ Pattern configurations (Capacitor layout on PCBs)

1-1. The following is examples of good and bad capacitor layouts ; capacitors shall be located to minimize any possible mechanical stresses from board warp or deflection.

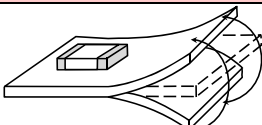
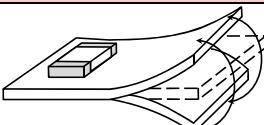
Items	Not recommended	Recommended
Deflection of board		

Place the product at a right angle to the direction of the anticipated mechanical stress.

1-2. The amount of mechanical stresses given will vary depending on capacitor layout. Please refer to diagram below.

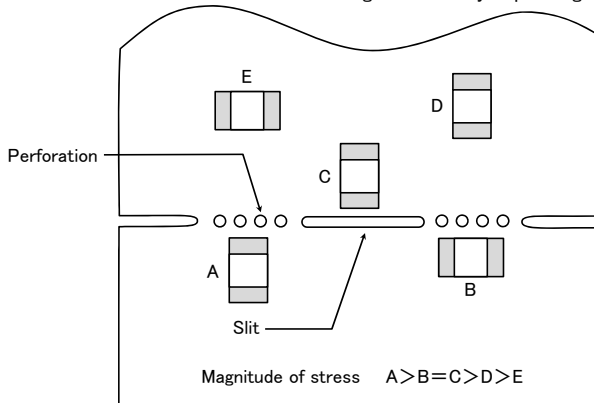

1-3. When PCB is split, the amount of mechanical stress on the capacitors can vary according to the method used. The following methods are listed in order from least stressful to most stressful: push-back, slit, V-grooving, and perforation. Thus, please consider the PCB, split methods as well as chip location.

3. Mounting

Precautions

◆ Adjustment of mounting machine

- When capacitors are mounted on PCB, excessive impact load shall not be imposed on them.
- Maintenance and inspection of mounting machines shall be conducted periodically.

◆ Selection of Adhesives

- When chips are attached on PCBs with adhesives prior to soldering, it may cause capacitor characteristics degradation unless the following factors are appropriately checked : size of land patterns, type of adhesive, amount applied, hardening temperature and hardening period. Therefore, please contact us for further information.

◆Adjustment of mounting machine

1. When the bottom dead center of a pick-up nozzle is too low, excessive force is imposed on capacitors and causes damages. To avoid this, the following points shall be considerable.
 - (1) The bottom dead center of the pick-up nozzle shall be adjusted to the surface level of PCB without the board deflection.
 - (2) The pressure of nozzle shall be adjusted between 1 and 3 N static loads.
 - (3) To reduce the amount of deflection of the board caused by impact of the pick-up nozzle, supporting pins or back-up pins shall be used on the other side of the PCB. The following diagrams show some typical examples of good and bad pick-up nozzle placement:

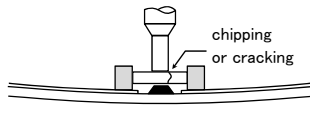
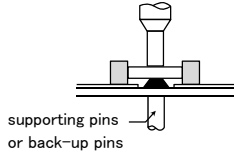
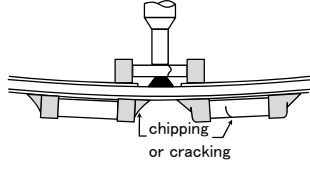
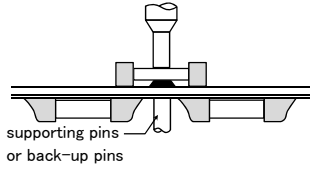
Item	Improper method	Proper method
Single-sided mounting		
Double-sided mounting		

Technical considerations

2. As the alignment pin is worn out, adjustment of the nozzle height can cause chipping or cracking of capacitors because of mechanical impact on the capacitors.
To avoid this, the monitoring of the width between the alignment pins in the stopped position, maintenance, check and replacement of the pin shall be conducted periodically.

◆Selection of Adhesives

Some adhesives may cause IR deterioration. The different shrinkage percentage of between the adhesive and the capacitors may result in stresses on the capacitors and lead to cracking. Moreover, too little or too much adhesive applied to the board may adversely affect components. Therefore, the following precautions shall be noted in the application of adhesives.

- (1) Required adhesive characteristics
 - a. The adhesive shall be strong enough to hold parts on the board during the mounting & solder process.
 - b. The adhesive shall have sufficient strength at high temperatures.
 - c. The adhesive shall have good coating and thickness consistency.
 - d. The adhesive shall be used during its prescribed shelf life.
 - e. The adhesive shall harden rapidly.
 - f. The adhesive shall have corrosion resistance.
 - g. The adhesive shall have excellent insulation characteristics.
 - h. The adhesive shall have no emission of toxic gasses and no effect on the human body.
- (2) The recommended amount of adhesives is as follows;

[Recommended condition]

Figure	212/316 case sizes as examples
a	0.3mm min
b	100 to 120 μm
c	Adhesives shall not contact land

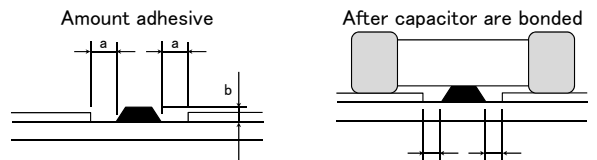

4. Soldering

◆Selection of Flux

- Since flux may have a significant effect on the performance of capacitors, it is necessary to verify the following conditions prior to use;
- (1) Flux used shall be less than or equal to 0.1 wt% (in Cl equivalent) of halogenated content. Flux having a strong acidity content shall not be applied.
 - (2) When shall capacitors are soldered on boards, the amount of flux applied shall be controlled at the optimum level.
 - (3) When water-soluble flux is used, special care shall be taken to properly clean the boards.

Precautions

◆Soldering

Temperature, time, amount of solder, etc. shall be set in accordance with their recommended conditions.
Sn-Zn solder paste can adversely affect MLOC reliability.
Please contact us prior to usage of Sn-Zn solder.

Technical considerations

◆Selection of Flux

- 1-1. When too much halogenated substance (Chlorine, etc.) content is used to activate flux, or highly acidic flux is used, it may lead to corrosion of terminal electrodes or degradation of insulation resistance on the surfaces of the capacitors.
- 1-2. Flux is used to increase solderability in wave soldering. However if too much flux is applied, a large amount of flux gas may be emitted and may adversely affect the solderability. To minimize the amount of flux applied, it is recommended to use a flux-bubbling system.
- 1-3. Since the residue of water-soluble flux is easily dissolved in moisture in the air, the residues on the surfaces of capacitors in high humidity conditions may cause a degradation of insulation resistance and reliability of the capacitors. Therefore, the cleaning methods and the capability of the machines used shall also be considered carefully when water-soluble flux is used.

▶ This catalog contains the typical specification only due to the limitation of space. When you consider the purchase of our products, please check our specification.
For details of each product (characteristics graph, reliability information, precautions for use, and so on), see our Web site (<http://www.ty-top.com/>).

◆Soldering

- Ceramic chip capacitors are susceptible to thermal shock when exposed to rapid or concentrated heating or rapid cooling.
- Therefore, the soldering must be conducted with great care so as to prevent malfunction of the components due to excessive thermal shock.
- Preheating : Capacitors shall be preheated sufficiently, and the temperature difference between the capacitors and solder shall be within 100 to 130°C.
- Cooling : The temperature difference between the capacitors and cleaning process shall not be greater than 100°C.

[Reflow soldering]

【Recommended conditions for eutectic soldering】

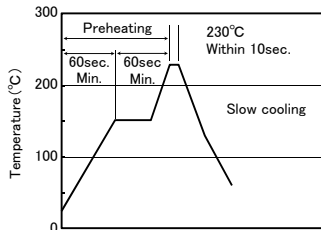

【Recommended condition for Pb-free soldering】

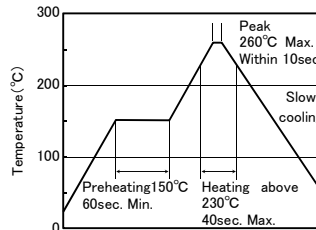

Caution

- ①The ideal condition is to have solder mass(fillet) controlled to 1/2 to 1/3 of the thickness of a capacitor.
- ②Because excessive dwell times can adversely affect solderability, soldering duration shall be kept as close to recommended times as possible.

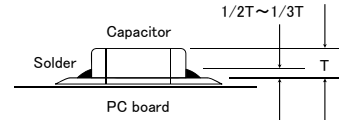

[Wave soldering]

【Recommended conditions for eutectic soldering】

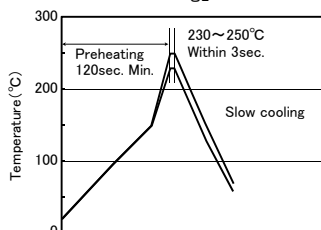

【Recommended condition for Pb-free soldering】

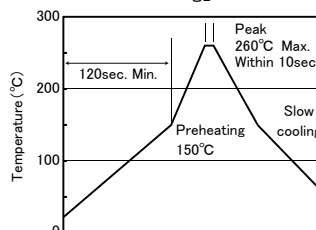

Caution

- ①Wave soldering must not be applied to capacitors designated as for reflow soldering only.

[Hand soldering]

【Recommended conditions for eutectic soldering】

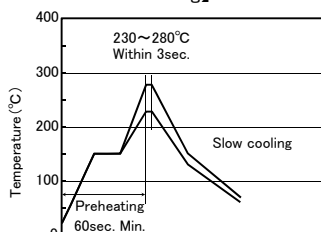

【Recommended condition for Pb-free soldering】

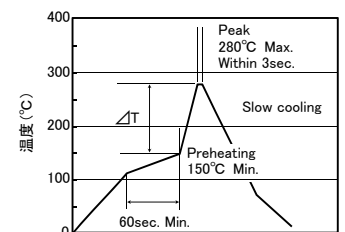
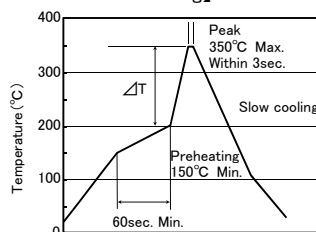

316type or less	$\Delta T \leq 150^{\circ}\text{C}$
-----------------	-------------------------------------

325type or more	$\Delta T \leq 130^{\circ}\text{C}$
-----------------	-------------------------------------

Caution

- ①Use a 50W soldering iron with a maximum tip diameter of 1.0 mm.
- ②The soldering iron shall not directly touch capacitors.

5. Cleaning

◆Cleaning conditions

Precautions

1. When PCBs are cleaned after capacitors mounting, please select the appropriate cleaning solution in accordance with the intended use of the cleaning. (e.g. to remove soldering flux or other materials from the production process.)
2. Cleaning condition shall be determined after it is verified by using actual cleaning machine that the cleaning process does not affect capacitor's characteristics.

Technical considerations

1. The use of inappropriate cleaning solutions can cause foreign substances such as flux residue to adhere to capacitors or deteriorate their outer coating, resulting in a degradation of the capacitor's electrical properties (especially insulation resistance).
2. Inappropriate cleaning conditions(insufficient or excessive cleaning) may adversely affect the performance of the capacitors. In the case of ultrasonic cleaning, too much power output can cause excessive vibration of PCBs which may lead to the cracking of capacitors or the soldered portion, or decrease the terminal electrodes' strength. Therefore, the following conditions shall be carefully checked:
 Ultrasonic output : 20 W/l or less
 Ultrasonic frequency : 40 kHz or less
 Ultrasonic washing period : 5 min. or less

▶ This catalog contains the typical specification only due to the limitation of space. When you consider the purchase of our products, please check our specification. For details of each product (characteristics graph, reliability information, precautions for use, and so on), see our Web site (<http://www.ty-top.com/>).

6. Resin coating and mold	
Precautions	<p>1. With some type of resins, decomposition gas or chemical reaction vapor may remain inside the resin during the hardening period or while left under normal storage conditions resulting in the deterioration of the capacitor's performance.</p> <p>2. When a resin's hardening temperature is higher than capacitor's operating temperature, the stresses generated by the excessive heat may lead to damage or destruction of capacitors. The use of such resins, molding materials etc. is not recommended.</p>
7. Handling	
Precautions	<p>◆Splitting of PCB</p> <p>1. When PCBs are split after components mounting, care shall be taken so as not to give any stresses of deflection or twisting to the board.</p> <p>2. Board separation shall not be done manually, but by using the appropriate devices.</p> <p>◆Mechanical considerations</p> <p>Be careful not to subject capacitors to excessive mechanical shocks.</p> <p>(1) If ceramic capacitors are dropped onto a floor or a hard surface, they shall not be used.</p> <p>(2) Please be careful that the mounted components do not come in contact with or bump against other boards or components.</p>
8. Storage conditions	
Precautions	<p>◆Storage</p> <p>1. To maintain the solderability of terminal electrodes and to keep packaging materials in good condition, care must be taken to control temperature and humidity in the storage area. Humidity should especially be kept as low as possible.</p> <p>•Recommended conditions</p> <p>Ambient temperature : Below 30°C Humidity : Below 70% RH</p> <p>The ambient temperature must be kept below 40°C. Even under ideal storage conditions, solderability of capacitor is deteriorated as time passes, so capacitors shall be used within 6 months from the time of delivery.</p> <p>•Ceramic chip capacitors shall be kept where no chlorine or sulfur exists in the air.</p> <p>2. The capacitance values of high dielectric constant capacitors will gradually decrease with the passage of time, so care shall be taken to design circuits. Even if capacitance value decreases as time passes, it will get back to the initial value by a heat treatment at 150°C for 1hour.</p>
Technical considerations	<p>If capacitors are stored in a high temperature and humidity environment, it might rapidly cause poor solderability due to terminal oxidation and quality loss of taping/packaging materials. For this reason, capacitors shall be used within 6 months from the time of delivery. If exceeding the above period, please check solderability before using the capacitors.</p>
<p>※RCR-2335B (Safety Application Guide for fixed ceramic capacitors for use in electronic equipment) is published by JEITA. Please check the guide regarding precautions for deflection test, soldering by spot heat, and so on.</p>	